

2014-15

CollegeBoard

Getting Ready for the SAT Subject Tests™

MATH | HISTORY | SCIENCE | LITERATURE | LANGUAGES



INFORMATION
ABOUT ALL 20 SAT
SUBJECT TESTS™



SAMPLE QUESTIONS
FOR ALL TESTS



TEST-TAKING
ADVICE AND TIPS

Find more free and affordable practice at www.SATSubjectTests.org.

A little practice goes a long way.

SAT®

Get ready for SAT Subject Tests™

Free SAT Subject Tests
practice tools at
sat.org/stpractice

The Official Study Guide for All SAT Subject Tests™

Visit store.collegeboard.org

- Actual tests for all 20 subjects
- Test-taking tips from the test maker

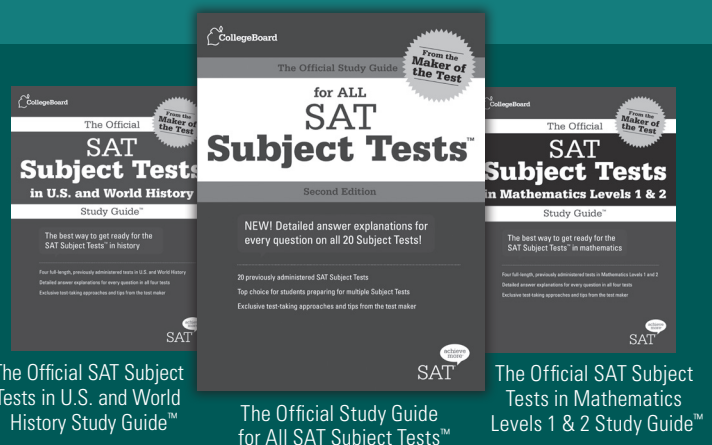

SAT®

 **CollegeBoard**

© 2014 The College Board.
13b-8637b

Introduction to the SAT Subject Tests and the College Board

If you have used a paper form to register for the SAT Subject Tests, you can use this booklet to get familiar with the tests. Remember, if you have access to the Internet you can find everything in this booklet, including free answer explanations for the booklet’s practice questions, at SATSubjectTest.org.

Contents

| | |
|---|----|
| Introduction to the SAT Subject Tests and the College Board | 1 |
| Literature | 5 |
| United States History | 8 |
| World History | 11 |
| Mathematics Level 1 <u>and</u> Level 2 | 14 |
| Biology E/M | 20 |
| Chemistry | 25 |
| Physics | 29 |
| Chinese with Listening | 34 |
| French <u>and</u> French with Listening | 39 |
| German <u>and</u> German with Listening | 45 |
| Modern Hebrew | 50 |
| Italian | 53 |
| Japanese with Listening | 55 |
| Korean with Listening | 58 |
| Latin | 62 |
| Spanish <u>and</u> Spanish with Listening | 64 |
| Acceptable Graphing Calculators | 68 |

Student Search Service® Program

Our Student Search Service is a voluntary program that connects students with information about educational and financial aid opportunities from more than 1,200 colleges, universities, scholarship programs, and educational organizations.

Here’s how it works:

1. Students may choose to participate in Student Search Service when registering for a College Board exam.
2. As part of taking a College Board exam, students are asked to fill out a Student Data Questionnaire (SDQ).
3. Participating, eligible organizations can then search for groups of students who may be a good fit for their communities and programs, but only among those students who opt to participate in Student Search Service.
4. The search criteria can include any attribute from the SDQ, except the following: disability, parental education, self-reported parental income, Social Security number, phone numbers, and actual test scores.
5. The most searched items are expected high school graduation date, cumulative grade point average (GPA), and intended

college major. A full list of SDQ questions is available in the Student Registration Guide.

If you have questions or concerns about Student Search Service or want more information about the program, please call (866) 825-8051.

Here are some points to keep in mind about Student Search Service:

- Most students who take SAT Subject Tests participate in this free service; however, you may take the tests even if you don’t take part in Student Search Service.
- Colleges participating in Student Search Service never receive student scores or phone numbers. Colleges can ask for names of students within certain score ranges, but your exact score is not reported.
- Being contacted by a college doesn’t mean you have been admitted. The colleges and organizations that participate want to find students who fit in with their environment, classes, programs, scholarships, and special activities. However, you can be admitted only after you apply. Student Search Service is simply a way for colleges to reach prospective students like you and inform students of their opportunities.
- Student Search Service will share your contact information only with colleges and qualified non-profit educational or scholarship programs that are recruiting students like you. Your name will never be sold to a commercial marketing firm or retailer of merchandise or services (such as test prep).

Why Should You Take SAT Subject Tests?

The SAT Subject Tests are one-hour-long exams that give you the opportunity to demonstrate knowledge and showcase achievement in specific subjects. They provide a fair and reliable measure of your achievement in high school — information that can help enhance your college application portfolio.

SAT Subject Tests measure how well you know a particular subject area and your ability to apply that knowledge. SAT Subject Tests aren’t connected to specific textbooks or teaching methods. The content of each test evolves to reflect the latest trends in what is taught in typical high school courses in the corresponding subject.

How Do Colleges Use SAT Subject Test Scores?

Colleges use SAT Subject Test scores to gain insight into your academic background and achievement in specific subject areas. They use this information, in combination with other factors (high school grades, letters of recommendation, extracurricular activities, essays, etc.), to make admission or placement decisions.

Even schools that don’t require the tests often review them during the application process because the scores can give a fuller picture of your academic achievement. Many colleges also use Subject Tests for course placement and advising; some schools allow you to place out of introductory courses by taking certain Subject Tests.

Which SAT Subject Tests Should You Take?

SAT Subject Tests are the only college admission tests where you can choose the subjects in which you are tested. You select the Subject Test(s) and can take up to three tests in one sitting. With the exception of listening tests, you can even decide to change the subject or number of tests you want to take on the day of the test.

The SAT Subject Tests that you take should be based on the subject areas you enjoy in school as well as your academic strengths. The tests are a great way to indicate interest in specific majors or programs of study (e.g., engineering, premed, cultural studies).

Certain colleges or programs of study require or recommend specific tests, such as mathematics or science, so it's important to make sure you understand the policies prior to choosing which Subject Tests to take. If you have questions or concerns about admission policies, contact admission officers at individual schools.

When Should You Take SAT Subject Tests?

Check the recommended preparation guidelines for each Subject Test at SATSubjectTest.org (click on each subject to view) to make sure you've completed the recommended course work. In general, you'll want to take SAT Subject Tests right after you've completed the recommended classes, even in your first or second years of high school, because the material will still be fresh in your mind. For language tests, however, you should consider testing after you've studied the language for at least two years.

Check online to see when the Subject Tests in which you are interested are offered. (**Note:** Beginning in 2015, Italian will only be offered in June.) You should also think about college application deadlines. Go to bigfuture.org to look up policies for specific colleges.

Still not sure when you should schedule your SAT Subject Tests? Talk to your school counselor or teacher to figure out the timing that works best for you.

How Can You Get Ready for the Tests?

- Take challenging classes, study hard, and learn classroom material.
- Visit SATSubjectTest.org to access free online practice tools. If you're preparing to take a Language with Listening Test, ask your college counselor to order a free SAT Subject Tests Practice CD from the College Board.
- Review the sample questions, test-taking approaches, and recommended study methods in this booklet and online. Look for free answer explanations for this booklet's practice questions at SATSubjectTest.org. There, you can find the practice pages for each Subject Test, and download answer explanations for the corresponding practice questions.
- Consider reviewing practice exams available in the following books, available for purchase in bookstores or online at store.collegeboard.org:
 - *The Official Study Guide for all SAT Subject Tests™, Second Edition* This is the only study guide with actual, full-length, previously administered tests for all 20 Subject Tests, with

detailed answer explanations so you know exactly what to expect on test day. It comes with two audio CDs for all six Language with Listening tests.

- *The Official SAT Subject Tests in Mathematics Levels 1 & 2 Study Guide™* This booklet includes four full-length, previously administered mathematics tests, detailed answer explanations, and the most up-to-date tips and approaches to help you be better prepared on test day.
- *The Official SAT Subject Tests in U.S. and World History Study Guide™* This guide includes four full-length, previously administered tests, detailed answer explanations, and the most up-to-date tips and approaches to help you prepare for the Subject Tests in United States History and World History.

Approaches to Taking the SAT Subject Tests

Know What to Expect

Use the information in this booklet and online to help avoid surprises on test day. For additional details, see SATSubjectTest.org.

- **Review the equipment you need for each test.** A calculator is required for the Mathematics Level 1 and Level 2 Subject Tests, and you are required to bring a CD player for Language with Listening Subject Tests.
- **Learn the test directions.** If you become familiar with the directions now, you'll leave yourself more time to answer the questions when you take the test. Note that some Subject Tests, such as Chemistry, may have special instructions.
- **Review the sample questions.** The more familiar you are with the question formats, the more comfortable you'll feel when you see similar questions on the actual test.
- **Understand how the tests are scored.** You get one point for each right answer and lose a fraction of a point for each wrong answer. You neither gain nor lose points for omitting an answer. Hard questions count the same amount as easier questions. You may not be able to complete all the questions in the time given, but it is not necessary to get every question correct to receive the highest score for the test. Refer to page 3 to learn more about how the tests are scored.

Use These Test-Taking Strategies

- **Read carefully.** Consider all the choices in each question. Avoid careless mistakes that will cause you to lose points.
- **Answer the easy questions first.** Work on less time-consuming questions before moving on to the more difficult ones. Questions on each test are generally ordered from easiest to hardest.
- **Eliminate answer choices that you know are wrong.** Cross them out in your test booklet so that you can clearly see which choices are left.
- **Make educated guesses or skip the question.** If you have eliminated the choices that you know are wrong, guessing is your best strategy. However, if you cannot eliminate any of the answer choices, it is best to skip the question. You will lose points for incorrect answers.

- **Keep your answer sheet neat.** The answer sheet is scored by a machine, which can't tell the difference between an answer and a doodle. If the machine reads marks that could be two answers for one question, it will consider the question unanswered.
- **Use your test booklet as scrap paper.** Use it to make notes or write down ideas. What you write in the booklet will not affect your score.
- **Circle the questions you've skipped.** This will help you keep track of which questions you've skipped.
- **Check your answer sheet regularly.** Make sure you are in the right place. Check the number of the question and the number on the answer sheet every few questions. This is especially important when you skip a question.
- **Work at an even, steady pace and keep moving.** Each question on the test takes a certain amount of time to read and answer. Through practice, you can develop a sense of timing to help you complete the test. Your goal is to spend time on the questions that you are most likely to answer correctly.
- **Keep track of time.** You are given one hour to complete each test. Occasionally check your progress so that you know where you are and how much time is left.
- **Remember to always use a No. 2 pencil.** All answer sheet circles must be filled in darkly and completely with a No. 2 pencil. If you need to erase an answer, erase it as completely as possible.
- **Do not try to erase all of your answers.** If you erase all of the answers to one of the tests you take on a given date, all of your tests you take that day will be canceled. Remember that you can choose which scores to send to colleges (see Score Choice™ on the next page).

On Test Day

Make sure that you read and understand our Test Day Requirements and Policies. These are available in three places:

- Online at sat.org/test-day
- In the Terms and Conditions you agree to during online registration
- In the *Student Registration Guide to the SAT and SAT Subject Tests*

Be sure to bring the following with you on test day, regardless of what Subject Test you plan on taking:

- Your Admission Ticket with photo, which is required for entry to the test center
- An acceptable photo ID (Be sure to check online or in the *Registration Guide* about what ID you can use.)
- Two No. 2 pencils and a soft eraser

The following Subject Tests require special equipment.

Mathematics Level 1 or Level 2

- **Make sure to bring an acceptable calculator to the test center.** See page 14 for more information about acceptable and unacceptable calculators and what to do if your calculator malfunctions.

- Make sure your calculator is in good working order. Insert new batteries the day before the test. You may bring additional batteries and a backup calculator to the test center.
- **You may not share a calculator with another test-taker.**

Language Tests with Listening

- **Bring an acceptable CD player to the test center.** Your CD player **MUST** be:
 - Equipped with earphones
 - Portable (handheld)
 - Battery operated (no power cords are allowed)
- **Your CD player should display this  icon.**
- **You are not allowed to use a CD player with recording or duplicating capabilities.**
- **Make sure your CD player is in good working order.** Insert new batteries the day before the test. If possible, bring extra batteries and a backup player to the test center. **Test center staff WILL NOT have equipment for your use.**
- **You may not share a CD player with another test-taker.**
- **If the volume on your CD player disturbs other test-takers, the test center supervisor may ask you to move to another seat.**
- **If your CD player malfunctions:**
 - Raise your hand and tell the test supervisor.
 - Switch to backup equipment, if you have it, and continue to test.
 - You may cancel your score on the listening test if you do not have backup equipment. Scores for other SAT Subject Tests you take that day will not be canceled.
- **If you encounter problems with your CD, such as occasional skipping, try to work through the problem and keep testing if possible. If necessary, raise your hand and ask the supervisor for a replacement CD. If a replacement is not available, a make-up test will be arranged.**

Test Scores

Scores are available for free at sat.collegeboard.org/scores several weeks after each test is given. You can also get your scores, for a fee, by calling Customer Service (see next page).

Each test is scored slightly differently depending on how many answer choices there are. See specific subject sections in this booklet for more information. The total score for each test is on a 200- to 800-point scale in 10-point intervals. All questions on the Subject Tests are multiple choice.

Each correct answer receives one point. Each incorrect answer is subtracted as follows:

- 1/4 point subtracted for each 5-choice question
- 1/3 point subtracted for each 4-choice question
- 1/2 point subtracted for each 3-choice question
- 0 points subtracted for questions you don't answer

Canceling Scores

On test day, if you want to cancel your scores, you must cancel scores for ALL SAT Subject Tests you take that day unless your equipment malfunctions. Visit sat.collegeboard.org/scores for more information about canceling scores.

Score Choice™

Score Choice gives you the option to choose the individual SAT Subject Test scores you send to colleges at no additional cost. Score Choice gives you an opportunity to show colleges the scores you feel best represent your abilities. Score Choice is optional, so if you don't actively choose to use it, all of your scores will be sent automatically with your score report. Since most colleges only consider your best scores, you should still feel comfortable reporting scores from all of your tests.

SAT Customer Service

You can reach us from 8 a.m. to 9 p.m. Eastern Time (8:30 a.m. to 8 p.m. in the summer).

Phone: 866-756-7346

International: +1-212-713-7789

Email: sat@info.collegeboard.org

Mail: College Board SAT Program

P.O. Box 025505

Miami, FL 33102

About the College Board

The College Board is a mission-driven not-for-profit organization that connects students to college success and opportunity. Founded in 1900, the College Board was created to expand access to higher education. Today, the membership association is made up of over 6,000 of the world's leading educational institutions and is dedicated to promoting excellence and equity in education. Each year, the College Board helps more than seven million students prepare for a successful transition to college through programs and services in college readiness and college success — including the SAT and the Advanced Placement Program®. The organization also serves the education community through research and advocacy on behalf of students, educators, and schools.

For further information, visit www.collegeboard.org.

Protecting Your Privacy

Student Search Service

Student Search Service communications are sent by outside colleges, scholarship programs, and educational opportunity organizations. All entities who receive student information from Student Search Service are required to maintain strict confidentiality. We actively monitor these entities to ensure adherence to our

guidelines. The frequency and mode of communication is determined by the entity which receives the student's name. Every communication from individual entities is required to contain specific instructions on how to unsubscribe from that particular institution. To unsubscribe from the entire Student Search Service program, call 800-626-9795 or write to: The College Board, 11955 Democracy Drive, Reston, VA 20190-5662, Attention: Student Search Service.

Telemarketing and Internet Scams

From time to time, we receive reports of phone scams in which callers posing as employees of the College Board contact students and families attempting to sell test-preparation products, or otherwise requesting sensitive personally identifying information, such as credit card and social security numbers. Some of these callers engage in illegal spoofing to make it seem as if the call is coming from the actual company. **These calls do not come from the College Board. The College Board does not make unsolicited phone calls to students or families requesting this type of information.** This type of activity, known as telemarketing fraud, is a crime. Should you receive an unsolicited phone call from someone claiming to work for the College Board, including where your Caller ID indicates that the telephone number originates from a College Board location, do not provide the caller with any personal information.

Representatives of the College Board only make calls or send text messages to students and their families in response to student-generated inquiries, or to provide or gather information about a test or program for which the student registered or regarding preparation for college and the application process. Should you have a question about the origin of a phone call you have received in which the caller claims to be from the College Board, contact us at 866-756-7346.

Safety and Security Tips

1. Be wary of unsolicited contacts, whether via telephone or email.
2. Remember that the College Board will never contact you to ask you to send your credit card, bank account, or password information over the telephone or through email.
3. Never supply credit card information to someone who calls or emails you.
4. If you suspect you have received a fraudulent call or email, contact the Federal Trade Commission (FTC) and your local authorities and provide them with all the details.
5. Keep in mind that if an offer appears too good to be true, it probably is.
6. To make a complaint, and to obtain more information about protecting yourself from telephone and Internet scams, visit the FTC's Consumer Information site at consumer.ftc.gov.

Literature

Questions cover topics emphasized in most high school courses. Because of course differences, most students will find that there are some questions on topics with which they are not familiar. You may not be able to complete all the questions in the time given, but it is not necessary to get every question correct to get a high score or even the highest score on the test.

Skills Covered

- Interpret themes and meanings of a text
- Understand both denotations and connotations of words in context
- Recognize the structure of a text, including genre, development, and organization
- Respond to a writer's use of language, including diction, imagery, and figurative language, and to its effects on the reader
- Analyze aspects of narration, including narrative voice, tone, and point of view
- Analyze poetry in terms of speaker, audience, occasion, and purpose
- Understand characterization in narrative and dramatic selections

Recommended Preparation

There is no suggested reading list to prepare for the Literature Subject Test. We recommend:

- Close, critical reading of English and American literature from a variety of historical periods and genres
- Reading of complete novels and plays, not just excerpts
- Understanding of basic literary terminology, such as *speaker*, *tone*, *image*, *irony*, *alliteration*, *stanza*
- Three or four years of literary study at the college-preparatory level
- Independent, critical reading of poetry, prose, and drama

| FORMAT/CONTENT | Approximate % of Test* |
|--|------------------------|
| About 60 multiple-choice questions | |
| Six to eight reading selections followed by sets of four to 12 questions | |
| Source of Questions | |
| English literature | 40%–50% |
| American literature | 40%–50% |
| Other literature written in English | 0%–10% |
| Chronology | |
| Renaissance and 17th century | 30% |
| 18th and 19th centuries | 30% |
| 20th century | 40% |
| Genre | |
| Poetry | 40%–50% |
| Prose | 40%–50% |
| Drama and other | 0%–10% |
| <i>*The distribution of passages may vary in different versions of the test. The chart above indicates typical or average content.</i> | |

Sample Questions

Questions on the Literature Subject Test are presented as sets of questions about reading selections. The directions that follow are identical to those in the test. All questions on the test are multiple-choice questions in which you must choose the BEST response from the five choices offered. For these sample materials and for the actual test, the date printed at the end of each passage or poem is the original publication date or, in some cases, the estimated date of composition.

Directions

This test consists of selections from literary works and questions on their content, form, and style. After reading each passage or poem, choose the best answer to each question and fill in the corresponding circle on the answer sheet.

Note: Pay particular attention to the requirements of questions that contain the words NOT, LEAST, or EXCEPT.

Questions 1-4. Read the following passage carefully before you choose your answers.

- By the time the man with the camera had cut across our neighbor's yard, the twins were out of the trees swingin low and Granny was onto the steps, the screen door bammin soft and scratchy against her palms.
- Line (5) "We thought we'd get a shot or two of the house and everything and then . . ."
- "Good mornin," Granny cut him off. And smiled that smile.
- "Good mornin," he said, head all down the way
- (10) Bingo does when you yell at him about the bones on the kitchen floor. "Nice place you got here, aunty. We thought we'd take a . . ."

“Did you?” said Granny with her eyebrows. Cathy pulled up her socks and giggled.

(15) “Nice things here,” said the man buzzin his camera over the yard. The pecan barrels, the sled, me and Cathy, the flowers, the painted stones along the driveway, the trees, the twins, the toolshed.

“I don’t know about the thing, the it, and the stuff,” said Granny still talkin with her eyebrows. “Just people here is what I tend to consider.”

Camera man stopped buzzin. Cathy giggled into her collar.

(25) “Mornin, ladies,” a new man said. He had come up behind us when we weren’t lookin. “And gents,” discoverin the twins givin him a nasty look. “We’re filmin for the county,” he said with a smile. “Mind if we shoot a bit around here?”

“I do indeed,” said Granny with no smile.

(30) Smilin man was smiling up a storm. So was Cathy. But he didn’t seem to have another word to say, so he and the camera man backed on out the yard, but you could hear the camera buzzin still.

(35) “Suppose you just shut that machine off,” said Granny real low through her teeth and took a step down off the porch and then another.

“Now, aunty,” Camera said pointin the thing straight at her.

“Your mama and I are not related.”

(1971)

4. The episode reveals a conflict between
- (A) propriety and impertinence
 - (B) virtue and corruption
 - (C) kindness and cruelty
 - (D) passiveness and aggression
 - (E) refinement and grossness

Questions 5-9. Read the following excerpt from a poem carefully before you choose your answers.

One summer evening (led by her)¹ I found
A little boat tied to a willow tree
Within a rocky cave, its usual home.
Line Straight I unloosed her chain, and stepping in
(5) Pushed from the shore. It was an act of stealth
And troubled pleasure, nor without the voice
Of mountain-echoes did my boat move on;
Leaving behind her still, on either side,
Small circles glittering idly in the moon,
(10) Until they melted all into one track
Of sparkling light. But now, like one who rows,
Proud of his skill, to reach a chosen point
With an unswerving line, I fixed my view
Upon the summit of a craggy ridge,
(15) The horizon’s utmost boundary; for above
Was nothing but the stars and the grey sky.
She was an elfin pinnacle;² lustily
I dipped my oars into the silent lake,
And, as I rose upon the stroke, my boat
(20) Went heaving through the water like a swan;
When, from behind that craggy steep till then
The horizon’s bound, a huge peak, black and huge,
As if with voluntary power instinct
Upreared its head. I struck and struck again,
(25) And growing still in stature the grim shape
Towered up between me and the stars, and still,
For so it seemed, with purpose of its own
And measured motion like a living thing,
Strode after me. With trembling oars I turned,
(30) And through the silent water stole my way
Back to the covert of the willow tree;
There in her mooring-place I left my bark, —
And through the meadows homeward went, in grave
And serious mood; but after I had seen
(35) That spectacle, for many days, my brain
Worked with a dim and undetermined sense
Of unknown modes of being; o’er my thoughts
There hung a darkness, call it solitude
Or blank desertion. No familiar shapes
(40) Remained, no pleasant images of trees,
Of sea or sky, no colours of green fields;
But huge and mighty forms, that do not live
Like living men, moved slowly through the mind
By day, and were a trouble to my dreams.

¹nature

(1850)

²a boat

1. After Granny’s “Good mornin” (line 7), the camera man probably behaves as he does because he
- (A) is made to realize that he is intruding
 - (B) suspects that he is in physical danger
 - (C) hopes to win Granny’s affection by appearing at ease
 - (D) is relieved that an adult is present
 - (E) realizes that he is disturbing the tidiness of the yard
2. The tone of “Now, aunty” (line 37) is most accurately described as
- (A) expectant
 - (B) patronizing
 - (C) accusatory
 - (D) obedient
 - (E) respectful
3. Granny’s final comment can best be understood as a
- (A) reluctant confession
 - (B) tentative assertion
 - (C) witty joke
 - (D) surprising revelation
 - (E) strong rebuke

5. The excerpt is best described as
- (A) an enthusiastic celebration of youthful optimism
 - (B) an ironic self-portrait colored by satiric observations
 - (C) an imaginative evocation without didactic intention
 - (D) a symbolic representation of intellectual creativity
 - (E) a narrative episode with philosophical implications
6. In lines 1-7, which of the following devices is used to present nature, the boat, and the mountain echoes?
- (A) Personification
 - (B) Apostrophe
 - (C) Rhyme
 - (D) Paradox
 - (E) Simile
7. In lines 6-7, “the voice/Of mountain-echoes” serves to reinforce the speaker’s sense of
- (A) freedom
 - (B) omnipotence
 - (C) furtiveness
 - (D) enthusiasm
 - (E) despondency
8. At the conclusion of the excerpt, the “huge peak” (line 22) seems to represent which of the following for the speaker?
- (A) An emblem of the beauty of the natural world
 - (B) A figure of undefined and unsettling significance
 - (C) An allegorical representation of sin itself
 - (D) A curious natural phenomenon
 - (E) A trivial figment of the speaker’s imagination
9. Which of the following best describes the change in the outlook of the speaker during the course of this excerpt?
- (A) Naïveté to cynicism
 - (B) Bravery to cowardice
 - (C) Hope to despair
 - (D) Daring to uncertainty
 - (E) Eagerness to sloth
10. The dramatic situation in the poem is that of
- (A) a youth speaking to a lover
 - (B) a priest speaking to a sinner
 - (C) a reformer addressing an impoverished person
 - (D) God addressing any human soul
 - (E) an individual addressing his or her own soul
11. In the context of the poem, “Painting thy outward walls so costly gay” (line 4) refers to
- (A) camouflage
 - (B) writing poetry
 - (C) attending to physical appearances
 - (D) pretending to be happy
 - (E) preparations for a celebration
12. The poet signals a major shift at line 9 by changing from
- (A) entirely negative to entirely positive imagery
 - (B) imagery of permanence to imagery of change
 - (C) direct address to impersonal statement
 - (D) material to spiritual imagery
 - (E) questions to commands
13. Which of the following best describes the theme of the concluding couplet (lines 13-14)?
- (A) A confession of sin before an almighty judge
 - (B) An affirmation of the immortality of the soul
 - (C) A declaration of rebellion against the powers of fate
 - (D) An accusation that death is a faithless servant
 - (E) A surrender to the inexplicable nature of life

ANSWERS

The difficulty of sample Literature questions is reported by the set only. (The complexity of a literary text often influences the difficulty of the questions asked about it.) Questions 1–4 overall are an easy set, questions 5–9 overall are a set of average difficulty, and questions 10–13 overall are a hard set.

| | | | | |
|------|------|------|-------|-------|
| 1. A | 4. A | 7. C | 10. E | 13. B |
| 2. B | 5. E | 8. B | 11. C | |
| 3. E | 6. A | 9. D | 12. E | |

Answer explanations for these practice questions are available online. Visit sat.collegeboard.org/practice/literature to view and download the complete document.

Poor soul, the centre of my sinful earth,
 Fenc'd by these rebel pow'rs that thee array,
 Why dost thou pine within and suffer dearth,
 Painting thy outward walls so costly gay?
 (5) Why so large cost, having so short a lease,
 Dost thou upon thy fading mansion spend?
 Shall worms, inheritors of this excess,
 Eat up thy charge? Is this thy body's end?
 Then, soul, live thou upon thy servant's loss,
 (10) And let that pine to aggravate thy store;
 Buy terms divine in selling hours of dross;
 Within be fed, without be rich no more:
 So shalt thou feed on Death, that feeds on men,
 And Death once dead, there's no more dying then.
 (1609)

United States History

Questions cover topics emphasized in most high school courses. Because of course differences, most students will find that there are some questions on topics with which they are not familiar. This is nothing to worry about. You may not be able to complete all the questions in the time given, but it is not necessary to get every question correct to get a high score or even the highest score on the test.

Skills Covered in the Context of United States History

- Understand historical terms, concepts, and generalizations
- Recall historical information and chronology
- Understand significant aspects of U.S. history
- Analyze and interpret primary sources
- Relate ideas to charts, maps, and graphs
- Evaluate sources for a given purpose

Recommended Preparation

- One-year comprehensive course in United States history at the college-preparatory level
- Social studies courses and outside reading

| FORMAT/CONTENT | Approximate % of Test |
|--|-----------------------|
| 90 multiple-choice questions | |
| Material Covered* | |
| Political history | 31%–35% |
| Economic history | 13%–17% |
| Social history | 20%–24% |
| Intellectual and cultural history | 13%–17% |
| Foreign policy | 13%–17% |
| Periods Covered | |
| Pre-Columbian history to 1789 | 20% |
| 1790–1898 | 40% |
| 1899 to the present | 40% |
| <i>*Social science concepts, methods, and generalizations are incorporated in this material.</i> | |

Sample Questions

All questions in the U.S. History Subject Test are multiple-choice questions in which you are asked to choose the BEST response from the five choices offered. The directions that follow are identical to those on the test.

Directions

Each of the questions or incomplete statements below is followed by five suggested answers or completions. Select the one that is BEST in each case and then fill in the corresponding circle on the answer sheet.

1. Which of the following best describes the pattern of immigration into Britain's North American colonies during the years 1620 to 1770?
 - (A) Largely English in the seventeenth century, non-English in the eighteenth century
 - (B) Chiefly of English origin during the whole period
 - (C) Largely non-English in the seventeenth century, English in the eighteenth century
 - (D) Predominantly from southern and eastern Europe, especially after 1700
 - (E) Predominantly from Asia, Africa, and Spanish America, especially after 1650
2. George Grenville viewed the Stamp Act primarily as a means to
 - (A) make the customs service more efficient
 - (B) punish rebellious colonists
 - (C) test the colonists' will to resist England
 - (D) create more patronage positions for the king's courtiers
 - (E) raise revenue for the crown
3. Which of the following statements is generally true of the framers of the Constitution?
 - (A) They believed in the supremacy of the executive branch of the federal government.
 - (B) They had great faith in the goodness and rationality of people.
 - (C) They were opposed to the development of political parties.
 - (D) They incorporated into the Constitution the most democratic ideals of the Declaration of Independence.
 - (E) They believed the new American republic would be stable because of the unanimity of public opinion in the country on major policy issues.

4. “What is man born for but to be a reformer, a remaker of what man has made; a renouncer of lies; a restorer of truth and good, imitating that great Nature which embosoms us all, and which sleeps no moment on an old past, but every hour repairs herself, yielding every morning a new day, and with every pulsation a new life?”
- These sentiments are most characteristic of
- (A) fundamentalism
 (B) Social Darwinism
 (C) pragmatism
 (D) neoorthodoxy
 (E) transcendentalism
5. From 1870 to 1930, the trend in industry was for hours to be generally reduced, while both money wages and real wages rose. What factor was primarily responsible for this trend?
- (A) A reduction in profit margins
 (B) Minimum-wage laws
 (C) Restriction of the labor supply
 (D) Increased output per hour of work
 (E) Right-to-work legislation
6. All of the following are true of the movement to prohibit alcoholic beverages in the United States EXCEPT:
- (A) It arose quite suddenly amid the hysteria surrounding the First World War.
 (B) It won the support of many progressive reformers.
 (C) It was often favored by people who disliked immigrants and their cultural practices.
 (D) It was a movement in which women played leading roles.
 (E) It gained strength from new scientific evidence that alcohol was harmful to health.
7. I. “I believe it is the duty of the Negro — as the greater part of the race is already doing — to deport himself modestly in regard to political claims, depending upon the slow but sure influences that proceed from the possession of property, intelligence, and high character for the full recognition of his political rights.”
- II. “The truth is that ‘integration’ is an *image*, it’s a foxy Northern liberal’s smoke-screen that confuses the true wants of the American black man.”
- III. “The talented tenth of the Negro race must be made leaders of thought and missionaries of culture among their people. . . . The Negro race, like all other races, is going to be saved by its exceptional men.”
- The most probable authors of statements I, II, and III, respectively, are
- (A) Malcolm X, Nat Turner, and Martin Luther King, Jr.
 (B) Booker T. Washington, Malcolm X, and W.E.B. Du Bois
 (C) Martin Luther King, Jr., Booker T. Washington, and W.E.B. Du Bois
 (D) Nat Turner, Martin Luther King, Jr., and Booker T. Washington
 (E) W.E.B. Du Bois, Malcolm X, and Martin Luther King, Jr.
8. Which of the following was symbolic of the rise of American influence in the fine arts after the Second World War?
- (A) Mary Cassatt’s work in Impressionism
 (B) Thomas Eakin’s work in Realism
 (C) Grant Wood’s work in Regionalism
 (D) Jackson Pollock’s work in Abstract Expressionism
 (E) John S. Copley’s work of realistic portraiture
9. Major population shifts between 1915 and 1980 included all of the following EXCEPT a movement from
- (A) the rural South to Northern cities
 (B) New England to the Midwest
 (C) the North to the Sun Belt
 (D) the inner cities to the suburbs
 (E) the Caribbean region to the American mainland
10. Which of the following presidents is correctly paired with an event that took place during his administration?
- (A) Lyndon B. Johnson . . . the establishment of diplomatic relations between the United States and the People’s Republic of China
 (B) John F. Kennedy . . . resolution of the Suez Crisis
 (C) Richard M. Nixon . . . the reduction of United States forces in Vietnam
 (D) Gerald R. Ford . . . the signing of the Camp David Accords
 (E) Jimmy Carter . . . resolution of the Cuban Missile Crisis

11. The Emancipation Proclamation declared slaves in which of the following areas “forever free”?
- (A) All areas of the United States
 - (B) All areas of the Confederacy
 - (C) Areas in border states loyal to the Union
 - (D) Confederate areas still in rebellion
 - (E) Areas in states controlled by Union forces
12. “The point I wish plainly to bring before you on this occasion is the individuality of each human soul; our Protestant idea, the right of individual conscience and judgment; our republican idea, individual citizenship. . . . If we consider [a woman] as a citizen, as a member of a great nation, she must have the same rights as all other members, according to the fundamental principles of our government.”

The statement above was made by

- (A) Thomas Jefferson
- (B) Elizabeth Blackwell
- (C) Henry David Thoreau
- (D) Margaret Sanger
- (E) Elizabeth Cady Stanton



13. The controversy with Great Britain over the northern boundary of the shaded section in the map above was settled during the presidency of
- (A) John Quincy Adams
 - (B) James K. Polk
 - (C) Franklin Pierce
 - (D) James Buchanan
 - (E) Andrew Johnson

14. A major change brought about by Franklin D. Roosevelt's New Deal, 1933–1939, was the

- (A) creation of machinery for maintaining full employment
- (B) transformation of a business-dominated society into a labor-dominated one
- (C) redistribution of population from urban centers to rural areas
- (D) development of new attitudes about the role and function of government
- (E) destruction of machine politics at the state and city levels



National Archives

15. The 1940s poster above referred to the

- (A) contribution of women to the defense industry
- (B) growing popularity of women movie stars
- (C) large number of women in the armed forces
- (D) large number of immigrants who supported the war effort
- (E) affection of Americans for their wartime president

ANSWERS

The estimated difficulty level, on a scale of 1 to 5, with 1 the easiest and 5 the most difficult, is in parentheses.

- | | | | |
|----------|----------|-----------|-----------|
| 1. A (2) | 5. D (4) | 9. B (3) | 13. B (2) |
| 2. E (2) | 6. A (4) | 10. C (3) | 14. D (3) |
| 3. C (3) | 7. B (5) | 11. D (3) | 15. A (2) |
| 4. E (5) | 8. D (3) | 12. E (3) | |

Answer explanations for these practice questions are available online. Visit sat.collegeboard.org/practice/ushistory to view and download the complete document.

World History

Questions cover topics emphasized in most high school courses. Because of course differences, most students will find that there are some questions on topics with which they are not familiar. You may not be able to complete all the questions in the time given, but it is not necessary to get every question correct to get a high score or even the highest score on the test.

Skills Covered in the Context of World History

- Show knowledge of facts and terms
- Understand cause-and-effect relationships
- Use knowledge of events and geography to demonstrate understanding of major historical developments
- Understand concepts essential to historical analysis
- Interpret artistic materials and assess quotations from published materials

Recommended Preparation

- One-year comprehensive course in world history at the college-preparatory level
- Independent reading of materials on historical topics

| FORMAT/CONTENT | Approximate % of Test |
|---|-----------------------|
| Approximately 90 to 95 multiple-choice questions | |
| Material Covered | |
| Global or comparative | 25% |
| Europe | 25% |
| Africa | 10% |
| Southwest Asia | 10% |
| South and Southeast Asia | 10% |
| East Asia | 10% |
| Americas | 10% |
| Periods Covered | |
| Prehistory and civilizations to 500 C.E.* | 25% |
| 500 to 1500 C.E. | 20% |
| 1500 to 1900 C.E. | 25% |
| Post-1900 C.E. | 20% |
| Cross-chronological | 10% |
| *The World History Subject Test uses the chronological designations B.C.E. (before common era) and C.E. (common era). These labels correspond to B.C. (before Christ) and A.D. (anno Domini), which are used in some world history textbooks. | |

Sample Questions

All questions in the World History Subject Test are multiple-choice questions in which you are asked to choose the BEST response from the five choices offered. The directions that follow are identical to those that are on the test.

Directions

Each of the questions or incomplete statements below is followed by five suggested answers or completions. Select the one that is BEST in each case and then fill in the corresponding circle on the answer sheet.

- Which of the following was an important virtue in Confucianism?
 - Warlike prowess
 - Filial piety
 - Public charity
 - Poverty
 - Manual labor
- Early Christians developed the monastic ideal as a means of counteracting
 - government interference
 - heresy
 - competition from Eastern religions
 - worldliness
 - persecution
- The Silk Routes were important in ancient times because they
 - facilitated the exchange of goods and ideas between China and the Roman Empire
 - allowed gold and silver mined in China to be traded for European furs and wool cloth
 - provided trade links between the people of Siberia and the people living on islands in the Bering Sea
 - provided a conduit for trade in silk, porcelain, and costly gems between China and Japan
 - allowed carts and carriages to travel on paved roads across northern Asia as far west as the Caspian Sea

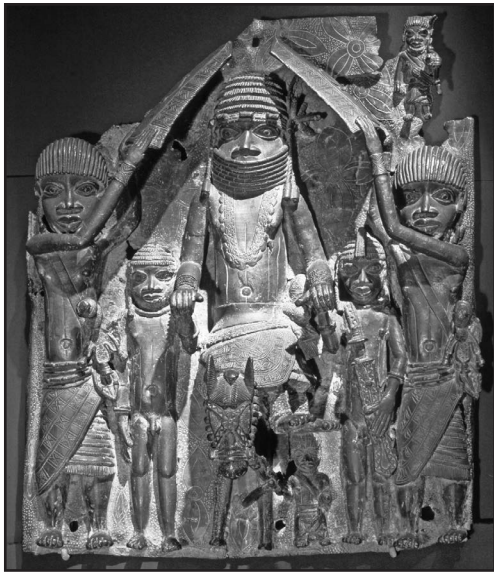

© Werner Forman / Art Resource, NY # ART133217

4. The bronze plaque shown above was created in
- (A) Italy
 - (B) Central Asia
 - (C) Arabia
 - (D) West Africa
 - (E) China
5. Which of the following was characteristic of the physical environments of early river-valley civilizations in the Near East?
- (A) Cool summer temperatures encouraged the production of grain crops.
 - (B) Tropical forests along the riverbanks provided the population with most of its food.
 - (C) The rivers maintained a steady flow year-round, fed by melting mountain glaciers.
 - (D) The rivers flowed through deep mountain valleys, which sheltered early civilizations.
 - (E) Rainfall was low, requiring irrigation of crops with river water.

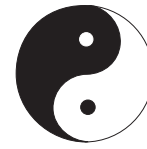

6. The ancient Chinese symbol of the universe shown above represented
- (A) the theory that everything consists of opposite but complementary elements
 - (B) the Zen concept of unity in artistic expression
 - (C) Buddha's vision of the perfect shape
 - (D) a dualism in which everything is in conflict, and nothing can be resolved
 - (E) the moral principles of Confucius

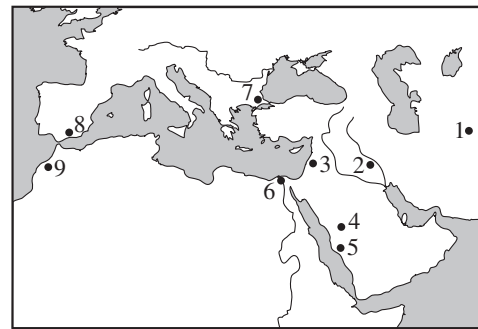

7. In the map above, the numbered dots correspond to cities. In the eighth century, which cities were near the east-west limits of the Islamic world?
- (A) 1 and 7
 - (B) 1 and 9
 - (C) 2 and 6
 - (D) 2 and 8
 - (E) 5 and 7
8. The *encomienda* system of colonial Spanish America most closely resembled the European practice of
- (A) absolutism
 - (B) primogeniture
 - (C) patronage
 - (D) manorialism
 - (E) nepotism
9. In early modern Europe, governments sought to increase national wealth and maintain a favorable balance of trade through government intervention by advocating
- (A) Liberalism
 - (B) Capitalism
 - (C) Socialism
 - (D) Utilitarianism
 - (E) Mercantilism

10. “Where it is an absolute question of the welfare of our country, we must admit of no considerations of justice or injustice, or mercy or cruelty, or praise or ignominy, but putting all else aside must adopt whatever course will save its existence and preserve its liberty.”

The statement above expresses the viewpoint of which of the following?

- (A) Niccolò Machiavelli
- (B) Sir Thomas More
- (C) Desiderius Erasmus
- (D) Dante Alighieri
- (E) John Calvin

11. Social Darwinists such as Herbert Spencer argued that

- (A) competition allows individuals to develop their talents and meet their needs
- (B) competition and cooperation are equally important in building a productive and compassionate society
- (C) human societies progress through competition, since the strong survive and the weak perish
- (D) human societies progress through cooperation, a natural instinct that should be encouraged
- (E) God predetermines that some members of society are fated to succeed and some members are fated to fail

12. Differences between which two religions contributed to violent conflicts in India during and after the struggle for independence in 1947?

- (A) Hinduism and Buddhism
- (B) Islam and Christianity
- (C) Hinduism and Islam
- (D) Islam and Buddhism
- (E) Hinduism and Jainism

13. Most of the noncitizens currently residing in Western European countries originally came to Western Europe to

- (A) consolidate the European Economic Community agreements
- (B) find employment
- (C) do graduate work in the universities
- (D) participate in the democratic political process
- (E) avoid forced military conscription in their native land

ANSWERS

The estimated difficulty level, on a scale of 1 to 5, with 1 the easiest and 5 the most difficult, is in parentheses.

- | | | | |
|----------|----------|-----------|-----------|
| 1. B (4) | 4. D (4) | 8. D (3) | 12. C (1) |
| 2. D (5) | 5. E (4) | 9. E (3) | 13. B (4) |
| 3. A (3) | 6. A (2) | 10. A (4) | |
| | 7. B (4) | 11. C (2) | |

Answer explanations for these practice questions are available online. Visit sat.collegeboard.org/practice/worldhistory to view and download the complete document.

Looking for More History Practice?

Get ready for test day with **The Official SAT Subject Tests in World History Study Guide™** — direct from the test maker!

- Four full-length, previously administered SAT Subject Tests™ in World History
- Detailed answer explanations for every question
- Exclusive test-taking tips and approaches

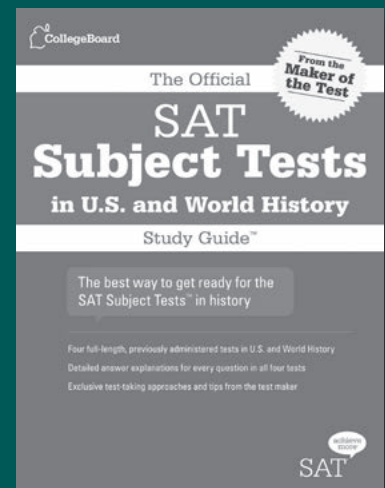

Order today at store.collegeboard.org

SAT

© 2014 The College Board.

Mathematics Level 1 and Level 2

Questions cover topics emphasized in most high school courses. Because of course differences, most students will find that there are some questions on topics with which they are not familiar. Students are not expected to have studied every topic on either test. You may not be able to complete all the questions in the time given, but it is not necessary to get every question correct to get a high score or even the highest score on the test.

Recommended Preparation

Mathematics Level 1

- Three years of college-preparatory mathematics, including two years of algebra and one year of geometry.

Mathematics Level 2

- More than three years of college-preparatory mathematics, including two years of algebra, one year of geometry, and elementary functions (precalculus) and/or trigonometry.
- If you have had preparation in trigonometry and elementary functions and have attained grades of B or better in these courses, select Level 2. If you are sufficiently prepared to take Level 2 but take Level 1 in hopes of receiving a higher score, you may not do as well as you expect.

Scores

Because the content measured by the two tests differs considerably, you cannot use your score on one test to predict your score on the other or to compare scores.

Calculators

Be sure to bring a calculator to use on these tests: If you take these tests without a calculator, you will be at a disadvantage. In fact, some questions cannot be solved without a scientific or a graphing calculator.

- Verify that your calculator is in good working condition before you take the test.
- If possible, bring batteries and a backup calculator to the test center. No substitute calculators or batteries will be available. Students may not share calculators.
- If your calculator malfunctions during the Level 1 or Level 2 test and you do not have a backup calculator, you can cancel scores on just the mathematics test. You must tell your test supervisor when the malfunction occurs in order to cancel scores on these tests only.

Types of Calculators Recommended

- Bring a calculator that you are used to using. Most graphing calculators (see page 68) and all scientific calculators are acceptable.
- We recommend the use of a graphing calculator over a scientific calculator because a graphing calculator may provide an advantage on some questions.

| FORMAT/CONTENT | Approximate % Level 1 Test | Approximate % Level 2 Test |
|---|----------------------------|----------------------------|
| 50 multiple-choice questions each | | |
| Topics Covered* <i>(topics in italics are tested on Level 2 Test only)</i> | Level 1 | Level 2 |
| Number and Operations Operations, ratio and proportion, complex numbers, counting, elementary number theory, matrices, sequences, <i>series, vectors</i> | 10%–14% | 10%–14% |
| Algebra and Functions Expressions, equations, inequalities, representation and modeling, properties of functions (linear, polynomial, rational, exponential, <i>logarithmic, trigonometric, inverse trigonometric, periodic, piecewise, recursive, parametric</i>) | 38%–42% | 48%–52% |
| Geometry and Measurement | 38%–42% | 28%–32% |
| Plane Euclidean/Measurement | 18%–22% | - |
| Coordinate Lines, parabolas, circles, <i>ellipses, hyperbolas, symmetry, transformations, polar coordinates</i> | 8%–12% | 10%–14% |
| Three-dimensional Solids, surface area and volume (cylinders, cones, pyramids, spheres, prisms), <i>coordinates in three dimensions</i> | 4%–6% | 4%–6% |
| Trigonometry Right triangles, identities, <i>radian measure, law of cosines, law of sines, equations, double angle formulas</i> | 6%–8% | 12%–16% |
| Data Analysis, Statistics and Probability Mean, median, mode, range, interquartile range, <i>standard deviation, graphs and plots, least-squares regression (linear, quadratic, exponential), probability</i> | 8%–12% | 8%–12% |
| *The content of Level 1 overlaps somewhat with that on Level 2, but the emphasis on Level 2 is on more advanced content. Plane Euclidean geometry is not tested directly on Level 2. | | |

Do NOT Bring These Unacceptable Calculators

- Laptops or other computers, tablets, cell phones, or smart phones
- Models that can access the Internet, have wireless, Bluetooth, cellular, audio/video recording and playing, camera, or any other smart phone type feature
- Models that have typewriter-like keypad, pen-input, or stylus
- Models that use electrical outlets, make noise, or have a paper tape
- In addition, the use of hardware peripherals such as a stylus with an approved calculator is not permitted. Some models with touch-screen capability are not permitted (e.g., Casio ClassPad). Check the list of acceptable calculators at the back of this booklet for models that are permitted.

Using the Calculator

You do not need to use a calculator to solve every question, and it is important to know when and how to use one. First decide how you will solve a problem; then determine whether the calculator is needed.

- You'll need a calculator for 40 to 50 percent of the questions on Level 1 and for 55 to 65 percent of the questions on Level 2.
- For the rest of the questions, there is no advantage, perhaps even a disadvantage, to using a calculator.
- **Do not round any intermediate calculations.** When you get a result from the calculator for the first step of a solution, keep the result in the calculator and use it for the second step. If you round the result from the first step, your answer may not be one of the choices.
- You may not use a calculator for other Subject Tests and must put it away when not taking a mathematics test.

Geometric Figures

Figures that accompany problems are intended to provide information useful in solving the problems. They are drawn as accurately as possible EXCEPT when it is stated in a particular problem that the figure is not drawn to scale. Even when figures are not drawn to scale, the relative positions of points and angles may be assumed to be in the order shown. Also, line segments that extend through points and appear to lie on the same line may be assumed to be on the same line. The text “Note: Figure not drawn to scale” is included on the figure when degree measures may not be accurately shown and specific lengths may not be drawn proportionally.

Geometric Probability

In any problem involving geometric probability, the assumption is that the feasible region is a part of the sample space. Example:

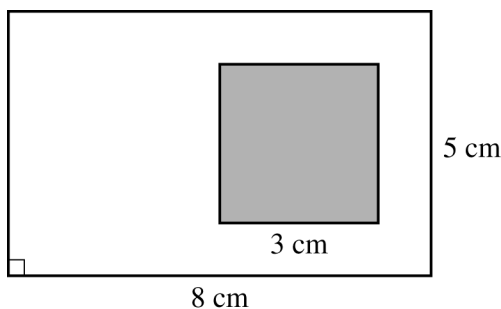

The figure above is a rectangular game board. What is the probability of randomly throwing a dart at the board such that it lands within the shaded square, assuming that the dart always lands within the boundary of the game board? (Answer: $\frac{9}{40}$)

The assumption is that the point inside the shaded square can be located anywhere in the region with the same probability.

Measures of Center

- The **mean** of a list of n numbers is equal to the sum of the numbers divided by n .

- The **median** of a list of numbers is the number in the middle when the numbers are ordered from least to greatest or from greatest to least. When there is an even number of values, the median is equal to the mean of the two middle numbers.
- A **mode** of a list of numbers is a number that occurs most often in the list. For example, 7 is the mode of 2, 7, 5, 8, 7, and 12. The list 2, 4, 2, 8, 2, 4, 7, 4, 9, and 11 has two modes, 2 and 4.

Calculating Quartiles

1. Arrange the data in order from least to greatest. The median of the data is the **second quartile**, Q2.
2. Now consider the lower half of the data. The median of these data is the **first (lower) quartile**, Q1.*
3. Next, consider the upper half of the data. The median of these data is the **third (upper) quartile**, Q3.*
4. Finally, the **interquartile range** (IQR) is equal to $Q3 - Q1$.
*Note: If the number of data points is odd, exclude Q2, the median of the entire data set, before separating it into halves to calculate Q1 or Q3.

Example: Consider the list 1, 2, 4, 5, 5, 5, 7, and 9. The mean is $\frac{43}{9}$. The mode is 5. Q1 is 3. Q2, the median, is 5. Q3 is 6. The IQR is 3.

Sample Questions

All questions in the Mathematics Level 1 and Mathematics Level 2 Subject Tests are multiple-choice questions in which you are asked to choose the BEST response from the five choices offered. The directions for the tests are below:

Directions

For each of the following problems, decide which is the **BEST** of the choices given. If the exact numerical value is not one of the choices, select the choice that best approximates this value. Then fill in the corresponding circle on the answer sheet.

Notes: (1) A scientific or graphing calculator will be necessary for answering some (but not all) of the questions in this test. For each question you will have to decide whether or not you should use a calculator.

(2) Level 1: The only angle measure used on this test is degree measure. Make sure your calculator is in the degree mode.

Level 2: For some questions in this test you may have to decide whether your calculator should be in the radian mode or the degree mode.

(3) Figures that accompany problems in this test are intended to provide information useful in solving the problems. They are drawn as accurately as possible EXCEPT when it is stated in a specific problem that its figure is not drawn to scale. All figures lie in a plane unless otherwise indicated.

(4) Unless otherwise specified, the domain of any function f is assumed to be the set of all real numbers x for which $f(x)$ is a real number. The range of f is assumed to be the set of all real numbers $f(x)$, where x is in the domain of f .

(5) Reference information that may be useful in answering the questions in this test can be found before Question 1.

Reference Information. The following information is for your reference in answering some of the questions in this test.

Volume of a right circular cone with radius r and height h : $V = \frac{1}{3}\pi r^2 h$

Volume of a sphere with radius r : $V = \frac{4}{3}\pi r^3$

Volume of a pyramid with base area B and height h :
 $V = \frac{1}{3}Bh$

Surface Area of a sphere with radius r : $S = 4\pi r^2$

Mathematics Level 1

1. A band wants to distribute its music on compact discs (CDs). The equipment to produce the CDs costs \$250, and blank CDs cost \$5.90 for a package of 10. Which of the following represents the total cost, in dollars, to produce n CDs, where n is a multiple of 10?

- (A) $(250 + 0.59)n$ (B) $250 + 0.59n$
 (C) $(250 + 5.90)n$ (D) $250 + 5.90n$
 (E) $250n + 5.90$

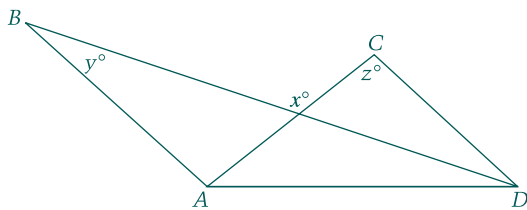

2. In the figure above, \overline{AB} and \overline{CD} are parallel. What is x in terms of y and z ?
- (A) $y + z$
 (B) $2y + z$
 (C) $2y - z$
 (D) $180 - y - z$
 (E) $180 + y - z$
3. A number n is increased by 8. If the cube root of that result equals -0.5 , what is the value of n ?
- (A) -15.625
 (B) -8.794
 (C) -8.125
 (D) -7.875
 (E) 421.875

4. If a and b are real numbers, $i^2 = -1$, and $(a + b) + 5i = 9 + ai$, what is the value of b ?
- (A) 4 (B) 5 (C) 9
 (D) $4 + 5i$ (E) $5 + 4i$
5. What are all values of x for which $4 - x^2 \geq x - 2$?
- (A) $x \geq -3$ (B) $-5 \leq x \leq 0$
 (C) $-3 \leq x \leq 2$ (D) $x \leq -3$ or $x \geq 2$
 (E) $-2 \leq x \leq 3$

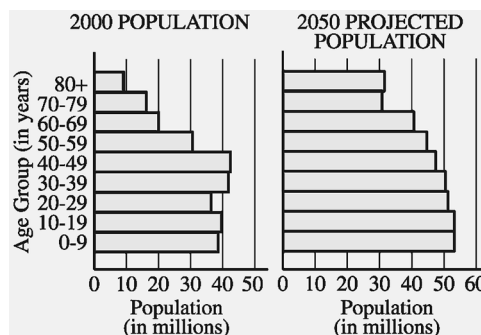

6. The graphs above show United States Census Bureau population figures for the year 2000 for various age groups, together with projections for the year 2050. Of the following age groups, for which is the projected percent increase in population from 2000 to 2050 greatest?
- (A) 30–39 (B) 40–49 (C) 50–59
 (D) 60–69 (E) 70–79
7. If $\log_c a = x$, which of the following must be true?
- (A) $a^c = x$ (B) $a^x = c$ (C) $c^a = x$
 (D) $c^x = a$ (E) $x^c = a$
8. If $f(x) = x + 3$ and $g(x) = \frac{x^2 - 9}{x - 3}$, which of the following statements are true about the graphs of f and g in the xy -plane?
- I. The graphs are exactly the same.
 II. The graphs are the same except when $x = 3$.
 III. The graphs have an infinite number of points in common.
- (A) I only (B) II only (C) III only
 (D) I and III (E) II and III

9. If line ℓ is the perpendicular bisector of the line segment with endpoints $(2, 0)$ and $(0, -2)$, what is the slope of line ℓ ?
- (A) 2 (B) 1 (C) 0
(D) -1 (E) -2
10. Twenty students have each sampled one or more of three kinds of candy bars that a school store sells. If 3 students have sampled all three kinds, and 5 have sampled exactly two kinds, how many of these students have sampled only one kind?
- (A) 8 (B) 12 (C) 15
(D) 17 (E) 18

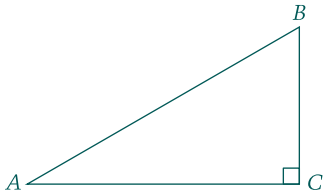

Note: Figure not drawn to scale.

11. In the figure above, $\triangle ABC$ has a right angle at C . If the length of side \overline{AC} is 10 and the measure of $\angle BAC$ is 22° , what is the length of side \overline{BC} ?
- (A) 3.7 (B) 4.0 (C) 5.8
(D) 6.8 (E) 9.3
12. The function h given by $h(t) = -16t^2 + 46t + 5$ represents the height of a ball, in feet, t seconds after it is thrown. To the nearest foot, what is the maximum height the ball reaches?
- (A) 5 (B) 23 (C) 35
(D) 38 (E) 46
13. The front, side, and bottom faces of a rectangular solid have areas of 24 square centimeters, 8 square centimeters, and 3 square centimeters, respectively. What is the volume of the solid, in cubic centimeters?
- (A) 24 (B) 96 (C) 192
(D) 288 (E) 576

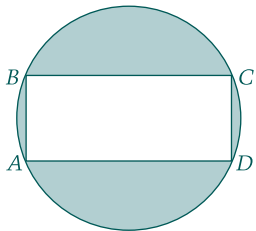

14. Rectangle $ABCD$ is inscribed in the circle shown above. If the length of side \overline{AB} is 5 and the length of side \overline{BC} is 12, what is the area of the shaded region?
- (A) 40.8 (B) 53.1 (C) 72.7
(D) 78.5 (E) 81.7

15. If $f(x) = x^4 - 3x^3 - 9x^2 + 4$, for how many real numbers k does $f(k) = 2$?
- (A) None (B) One (C) Two
(D) Three (E) Four

| Time t (years) | 0 | 1 | 2 | 5 |
|---------------------------|--------|--------|--------|-------|
| Value $v(t)$ (dollars) | 15,000 | 13,000 | 10,900 | 3,000 |

16. When purchased, an automobile is valued at \$15,000. Its value depreciates at the rate shown in the table above. Based on a least-squares linear regression, what is the value, to the nearest hundred dollars, of the automobile when $t = 4$?
- (A) \$5,400 (B) \$5,500 (C) \$5,600
(D) \$6,400 (E) \$7,000

Mathematics Level 2

17. What is the distance in space between the points with coordinates $(-3, 6, 7)$ and $(2, -1, 4)$?
- (A) 4.36 (B) 5.92 (C) 7.91
(D) 9.11 (E) 22.25
18. If $f(x) = \frac{3x + 12}{2x - 12}$, what value does $f(x)$ approach as x gets infinitely larger?
- (A) -6 (B) $-\frac{3}{2}$ (C) -1
(D) $\frac{2}{3}$ (E) $\frac{3}{2}$
19. In January 1990 the world's population was 5.3 billion. Assuming a growth rate of 2 percent per year, the world's population, in billions, for t years after 1990 can be modeled by the equation $P = 5.3(1.02)^t$. According to the model, the population growth from January 1995 to January 1996 was
- (A) 106,000,000
(B) 114,700,000
(C) 117,000,000
(D) 445,600,000
(E) 562,700,000
20. What is the measure of one of the larger angles of a parallelogram in the xy -plane that has vertices with coordinates $(2, 1)$, $(5, 1)$, $(3, 5)$, and $(6, 5)$?
- (A) 93.4° (B) 96.8° (C) 104.0°
(D) 108.3° (E) 119.0°

21. For some real number t , the first three terms of an arithmetic sequence are $2t$, $5t - 1$, and $6t + 2$. What is the numerical value of the fourth term?

- (A) 4 (B) 8 (C) 10
(D) 16 (E) 19

22. The diameter and height of a right circular cylinder are equal. If the volume of the cylinder is 2, what is the height of the cylinder?

- (A) 1.37 (B) 1.08 (C) 0.86
(D) 0.80 (E) 0.68

23. If $\sin \theta = 0.57$, then $\sin(\pi - \theta) =$

- (A) -0.57 (B) -0.43 (C) 0
(D) 0.43 (E) 0.57

24. In a group of 10 people, 60 percent have brown eyes. Two people are to be selected at random from the group. What is the probability that neither person selected will have brown eyes?

- (A) 0.13 (B) 0.16 (C) 0.25
(D) 0.36 (E) 0.64

25. If $x - 2$ is a factor of $x^3 + kx^2 + 12x - 8$, then $k =$

- (A) -6 (B) -3 (C) 2
(D) 3 (E) 6

26. If $f(x) = \sqrt[3]{x^3 + 1}$, what is $f^{-1}(1.5)$?

- (A) 3.4 (B) 2.4 (C) 1.6
(D) 1.5 (E) 1.3

| | | | | |
|-----|------|------|-------|------|
| x | -9.8 | -0.9 | 5.2 | 8.8 |
| y | 0.12 | 2.43 | 18.46 | 68.4 |

27. Which of the following equations best models the data in the table above?

- (A) $y = -3.3(1.4)^x$
(B) $y = -1.4(3.3)^x$
(C) $y = 1.4(3.3)^x$
(D) $y = 3.3(1.4)^x$
(E) $y = 1.4x^{3.3}$

$$C = -1.02F + 93.63$$

28. The linear regression model above is based on an analysis of nutritional data from 14 varieties of cereal bars to relate the percent of calories from fat (F) to the percent of calories from carbohydrates (C). Based on this model, which of the following statements must be true?

- I. There is a positive correlation between C and F .
II. When 20 percent of calories are from fat, the predicted percent of calories from carbohydrates is approximately 73.
III. The slope indicates that as F increases by 1, C decreases by 1.02.
- (A) II only (B) I and II only
(C) I and III only (D) II and III only
(E) I, II, and III

29. A line has parametric equations $x = 5 + t$ and $y = 7 + t$, where t is the parameter. The slope of the line is

- (A) $\frac{5}{7}$ (B) 1 (C) $\frac{7+t}{5+t}$
(D) $\frac{7}{5}$ (E) 7

30. What is the range of the function defined by

$$f(x) = \frac{1}{x} + 2?$$

- (A) All real numbers
(B) All real numbers except $-\frac{1}{2}$
(C) All real numbers except 0
(D) All real numbers except 2
(E) All real numbers between 2 and 3

31. The number of hours of daylight, d , in Hartsville can be modeled by

$$d = \frac{35}{3} + \frac{7}{3} \sin\left(\frac{2\pi}{365}t\right),$$

where t is the number of days after March 21. The day with the greatest number of hours of daylight has how many more daylight hours than May 1? (March and May have 31 days each. April and June have 30 days each.)

- (A) 0.8 hr (B) 1.5 hr (C) 2.3 hr
(D) 3.0 hr (E) 4.7 hr

| | Day 1 | Day 2 | Day 3 |
|---------|-------|-------|-------|
| Model X | 20 | 18 | 3 |
| Model Y | 16 | 5 | 8 |
| Model Z | 19 | 11 | 10 |

32. The table above shows the number of digital cameras that were sold during a three-day sale. The prices of models X, Y, and Z were \$99, \$199, and \$299, respectively. Which of the following matrix representations gives the total income, in dollars, received from the sale of the cameras for each of the three days?

(A) $\begin{bmatrix} 20 & 18 & 3 \\ 16 & 5 & 8 \\ 19 & 11 & 10 \end{bmatrix} \begin{bmatrix} 99 & 199 & 299 \end{bmatrix}$

(B) $\begin{bmatrix} 20 & 18 & 3 \\ 16 & 5 & 8 \\ 19 & 11 & 10 \end{bmatrix} \begin{bmatrix} 99 \\ 199 \\ 299 \end{bmatrix}$

(C) $\begin{bmatrix} 99 & 199 & 299 \end{bmatrix} \begin{bmatrix} 20 & 18 & 3 \\ 16 & 5 & 8 \\ 19 & 11 & 10 \end{bmatrix}$

(D) $\begin{bmatrix} 99 \\ 199 \\ 299 \end{bmatrix} \begin{bmatrix} 20 & 18 & 3 \\ 16 & 5 & 8 \\ 19 & 11 & 10 \end{bmatrix}$

(E) $99 \begin{bmatrix} 20 & 18 & 3 \\ 16 & 5 & 8 \\ 19 & 11 & 10 \end{bmatrix} + 199 \begin{bmatrix} 20 & 18 & 3 \\ 16 & 5 & 8 \\ 19 & 11 & 10 \end{bmatrix} + 299 \begin{bmatrix} 20 & 18 & 3 \\ 16 & 5 & 8 \\ 19 & 11 & 10 \end{bmatrix}$

ANSWERS

The estimated difficulty level, on a scale of 1 to 5, with 1 the easiest and 5 the most difficult, is in parentheses.

Mathematics Level 1

- | | | | |
|----------|----------|-----------|-----------|
| 1. B (2) | 5. C (3) | 9. D (4) | 13. A (4) |
| 2. A (2) | 6. D (4) | 10. B (3) | 14. C (4) |
| 3. C (2) | 7. D (3) | 11. B (3) | 15. E (3) |
| 4. A (3) | 8. E (3) | 12. D (4) | 16. C (5) |

Mathematics Level 2

- | | | | |
|-----------|-----------|-----------|-----------|
| 17. D (2) | 21. E (4) | 25. A (2) | 29. B (3) |
| 18. E (2) | 22. A (3) | 26. E (4) | 30. D (3) |
| 19. C (4) | 23. E (3) | 27. D (4) | 31. A (4) |
| 20. C (4) | 24. A (4) | 28. D (4) | 32. C (3) |

Answer explanations for these practice questions are available online. Visit sat.collegeboard.org/practice/math to view and download the complete document.

Looking for More Math Practice?

Get ready for test day with **The Official SAT Subject Tests in Mathematics Levels 1 & 2 Study Guide™** — direct from the test maker!

- Four full-length, previously administered SAT Subject Tests™ in Mathematics Levels 1 and 2
- Detailed answer explanations for every question
- Exclusive test-taking tips and approaches

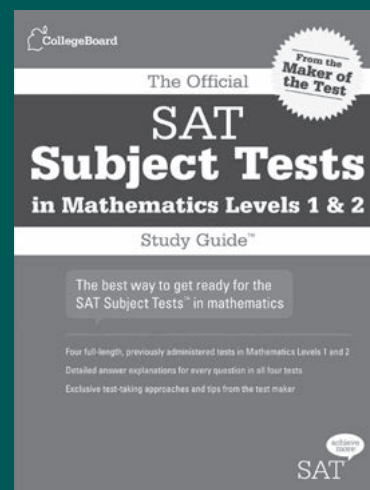

Order today at store.collegeboard.org

SAT

© 2014 The College Board.

Biology E/M

Questions cover topics emphasized in most high school courses. Because of course differences, most students will find that there are some questions on topics with which they are not familiar. You may not be able to complete all the questions in the time given, but it is not necessary to get every question correct to get a high score or even the highest score on the test.

The first 60 of the 80 questions are common to both Biology-E and Biology-M, followed by 20 specialized questions for each section.

How to Choose Between Biology-E and Biology-M

- Take Biology-E if you feel more comfortable answering questions pertaining to ecology, evolution, and diversity.
- Take Biology-M if you feel more comfortable answering questions pertaining to biochemistry, cellular structure, and processes, such as respiration and photosynthesis.

Once you decide which emphasis to take, you need to fill in the appropriate circle for the test you have chosen on your answer sheet.

Important: If you change your mind, you must change the circle on the answer sheet to match your test; otherwise, your answers to the 20 specialized questions will not be scored correctly.

You are not allowed to take both Biology-E and Biology-M on the same test date. You can take them on two different test dates.

Skills Covered in Both Biology-E and Biology-M

- Knowing fundamental concepts; remembering specific facts; demonstrating straightforward knowledge of information and familiarity with terminology (about 30% of test)
- Understanding concepts and reformulating information into other equivalent forms; applying knowledge to unfamiliar and/or practical situations; solving problems using mathematical relationships (about 35% of test)
- Interpreting, inferring, and deducing from qualitative and quantitative data and integrating information to form conclusions; recognizing unstated assumptions (about 35% of test)

Important Things to Note on This Subject Test

- Calculator use is not permitted.
- Problem solving requires simple numerical calculations.
- The metric system of units is used.

Recommended Preparation

- One-year course in biology
- One-year course in algebra and familiarity with simple algebraic concepts such as ratios and direct and inverse proportions
- Laboratory experience

| FORMAT/CONTENT | Approximate % Test E | Approximate % Test M |
|--|----------------------|----------------------|
| Total of 80 questions answered by each test-taker: | | |
| <ul style="list-style-type: none"> 60 multiple-choice questions that are common to both Biology-E and Biology-M 20 specialized multiple-choice questions for either Biology-E or Biology-M | | |
| Cell and Molecular Biology Cell structure and organization, mitosis, photosynthesis, cellular respiration, enzymes, biosynthesis, biological chemistry | 12% | 25% |
| Ecology Energy flow, nutrient cycles, populations, communities, ecosystems, biomes, biodiversity, effects of human intervention | 25% | 12% |
| Genetics Meiosis, Mendelian genetics, inheritance patterns, molecular genetics | 12% | 25% |
| Organismal Biology Structure, function and development of organisms (with emphasis on plants and animals), animal behavior | 25% | 25% |
| Evolution and Diversity Origin of life, evidence of evolution, patterns of evolution, natural selection, speciation, classification and diversity of organisms | 25% | 12% |

Sample Questions

All of the questions in the test are multiple-choice questions for which you must choose the BEST response from the five choices offered. Some questions that refer to a common figure, table, or laboratory experiment are grouped in sets.

Biology E/M Core Section

Directions

Each set of lettered choices below refers to the numbered questions or statements immediately following it. Select the one lettered choice that best answers each question or best fits each statement and then fill in the corresponding circle on the answer sheet. A choice may be used once, more than once, or not at all in each set.

Questions 1-2

- (A) Decomposers (e.g., bacteria)
 - (B) Producers (e.g., grasses)
 - (C) Primary consumers (e.g., mice)
 - (D) Secondary consumers (e.g., snakes)
 - (E) Tertiary consumers (e.g., hawks)
1. Organisms that comprise the greatest mass of living substance (biomass) in a terrestrial food chain
 2. Organisms that convert nitrogen-containing organic molecules into nitrates

Directions

Each of the questions or incomplete statements below is followed by five suggested answers or completions. Some questions pertain to a set that refers to a laboratory or experimental situation. For each question, select the one choice that is the best answer to the question and then fill in the corresponding circle on the answer sheet.

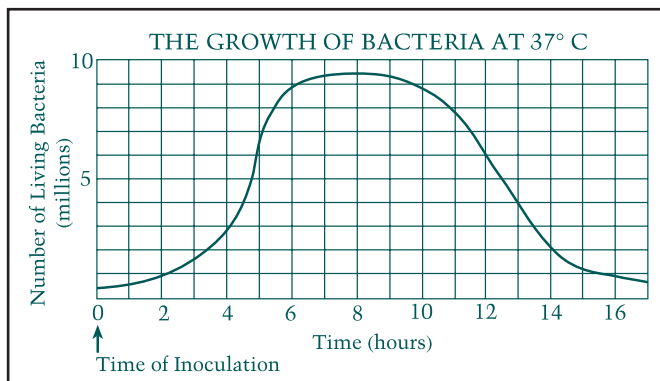

3. In the graph above, the time when the number of living bacteria is increasing at the greatest rate occurs
 - (A) during the first 2 hours
 - (B) between the 2nd and the 4th hour
 - (C) between the 4th and the 6th hour
 - (D) between the 6th and the 10th hour
 - (E) between the 11th and the 13th hour
4. ATP is produced during which of the following processes?
 - I. Photosynthesis
 - II. Aerobic respiration
 - III. Fermentation
 - (A) I only (B) II only (C) I and III only
 - (D) II and III only (E) I, II, and III
5. All of the following are population characteristics EXCEPT
 - (A) number of individuals
 - (B) phenotype
 - (C) sex ratio
 - (D) age distribution
 - (E) death rate

Questions 6-7 refer to the following diagram:

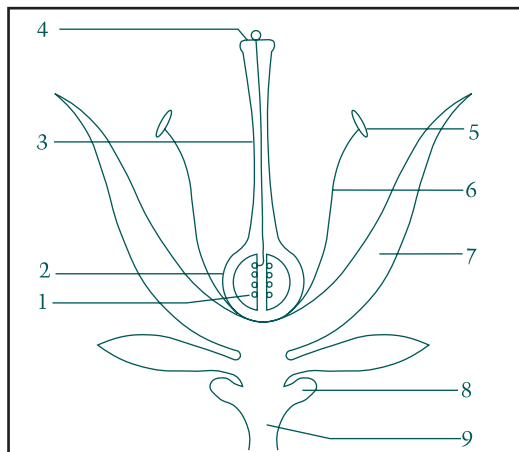

6. Commonly, the fruit is derived from

- (A) 2 (B) 4 (C) 7
(D) 8 (E) 9

7. Pollination involves a transfer of pollen from

- (A) 4 to 1 (B) 4 to 2 (C) 4 to 5
(D) 5 to 4 (E) 5 to 9

Questions 8-9

In a breeding experiment using gray and white mice of unknown genotypes, the following results were obtained.

| Cross | Parents | | Offspring | |
|-------|---------|---------|-----------|-------|
| | Female | Male | Gray | White |
| I | Gray | x White | 82 | 78 |
| II | Gray | x Gray | 118 | 39 |
| III | White | x White | 0 | 50 |
| IV | Gray | x White | 74 | 0 |

8. If the gray female from cross IV were mated with the gray male from cross II, then which of the following would most likely be true?

- (A) All of the offspring would be gray.
(B) All of the offspring would be white.
(C) Half of the offspring would be gray.
(D) One-quarter of the offspring would be gray.
(E) One-quarter of the offspring would be white.

9. If two gray progeny of cross IV mate with each other, what is the probability that any one individual offspring will be gray?

- (A) 100% (B) 75% (C) 50%
(D) 25% (E) 0

Questions 10-11

Three students added equal volumes of pond water to each of four beakers (I-IV) and placed each in a different constant temperature bath, maintained at 5°C, 15°C, 25°C, and 35°C, respectively. The students then added 6 water fleas, *Daphnia pulex*, to each of the four beakers and recorded the time in each case. After 1 hour, the students removed 3 *Daphnia pulex* from each beaker and each student immediately observed one *Daphnia pulex* under low-power magnification of a light microscope. (The transparent body of the *Daphnia pulex* can be seen easily under a light microscope.) Heart rates were recorded as beats per minute. The results of the experiment are summarized in the chart below.

| BEAKER | TEMPERATURE | TIME DAPHNIA ADDED | TIME DAPHNIA REMOVED | HEARTBEATS PER MINUTE (average of 3 <i>Daphnia</i>) |
|--------|-------------|--------------------|----------------------|--|
| I | 5°C | 2:00 p.m. | 3:00 p.m. | 41 |
| II | 15°C | 2:10 p.m. | 3:10 p.m. | 119 |
| III | 25°C | 2:20 p.m. | 3:20 p.m. | 202 |
| IV | 35°C | 2:30 p.m. | 3:30 p.m. | 281 |

10. The independent variable in this experiment is the

- (A) amount of light
(B) number of water fleas
(C) pH of the water
(D) temperature of the water
(E) average heart rate

11. If a graph is constructed using the data given in the table, it will most closely resemble which of the following?

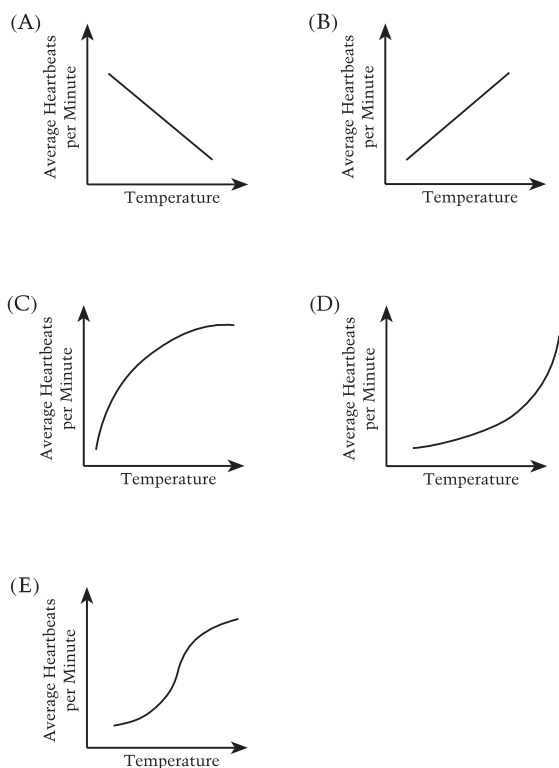

Biology-E Section

12. Which of the following individuals is most fit in evolutionary terms?
- (A) A child who does not become infected with any of the usual childhood diseases, such as measles or chicken pox
 - (B) A woman of 40 with seven adult offspring
 - (C) A woman of 80 who has one adult offspring
 - (D) A 100-year old man with no offspring
 - (E) A childless man who can run a mile in less than five minutes

Questions 13-14

Known numbers of seeds from two species (X and Y) of annual plants are mixed together in different proportions and planted in five small plots of soil in the spring. The plants grow, flower, and produce seeds. It is found that the percentage of seeds of species X and species Y in the harvest is usually different from the proportion that was planted, although the total number of seeds produced is the same as the number of seeds planted. The data are plotted on the graph below.

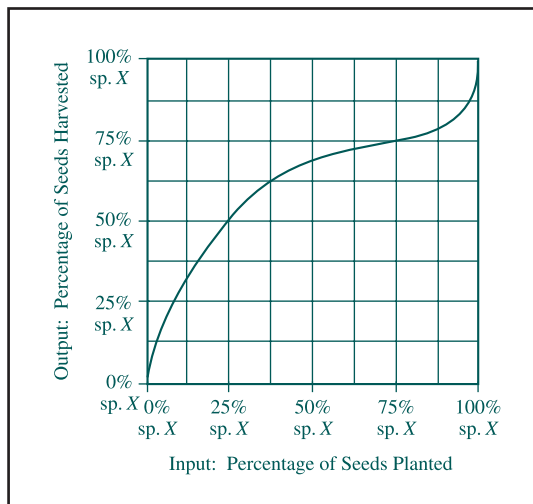

13. What mixture of seeds was harvested in the plot that was planted with 25 percent species X and 75 percent species Y ?

| | X | Y |
|-----|-----|-----|
| (A) | 25% | 75% |
| (B) | 40% | 60% |
| (C) | 50% | 50% |
| (D) | 60% | 40% |
| (E) | 75% | 25% |

14. What do the data indicate about the ecological relationship between species X and species Y ?

- (A) X and Y are mutualistic for low percentages of X seeds.
- (B) X and Y are mutualistic for high percentages of X seeds.
- (C) X and Y compete when both X and Y seeds are present.
- (D) Y competes successfully against X at all percentages of X and Y seeds.
- (E) X is a parasite of Y when Y is rare.

Biology-M Section

15. Which of the following most accurately reveals common ancestry among many different species of organisms?
- (A) The amino acid sequence of their cytochrome C
 - (B) Their ability to synthesize hemoglobin
 - (C) The percentage of their body weight that is fat
 - (D) The percentage of their body surface that is used in gas exchange
 - (E) The mechanism of their mode of locomotion

Questions 16-17

Thymine is used by animal cells primarily for the synthesis of DNA. A group of sea urchin eggs was fertilized in sea water containing radioactive thymine. Following fertilization, samples of embryos were removed at regular intervals and the radioactivity in the nucleic acid was measured in counts per minute. The results obtained are shown in the figure below.

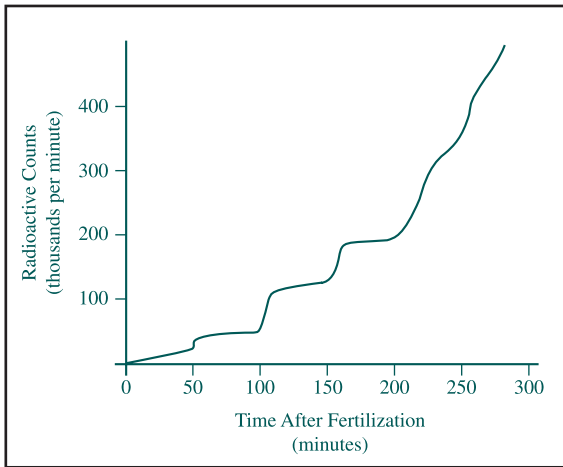

16. The increase in radioactivity of the embryos with time probably results from
- (A) synthesis of new proteins by the developing embryos
 - (B) synthesis of radioactive thymine by the developing embryos
 - (C) oxidation of radioactive thymine
 - (D) incorporation of radioactive thymine in new cell membranes
 - (E) incorporation of radioactive thymine in new DNA during replication

17. An appropriate control to show that this experiment measures DNA synthesis and not RNA synthesis would be to perform the same procedures but
- (A) not fertilize the eggs
 - (B) sample the embryos at longer time intervals
 - (C) add radioactive uracil instead of radioactive thymine
 - (D) fertilize the eggs in sea water that does not contain radioactive thymine
 - (E) count the number of cells in the embryos at the beginning and at the end of the experiment

ANSWERS

The estimated difficulty level, on a scale of 1 to 5, with 1 the easiest and 5 the most difficult, is in parentheses.

- | | | | |
|----------|-----------|-----------|-----------|
| 1. B (1) | 6. A (1) | 11. B (4) | 16. E (4) |
| 2. A (3) | 7. D (3) | 12. B (3) | 17. C (3) |
| 3. C (3) | 8. A (4) | 13. C (3) | |
| 4. E (2) | 9. B (4) | 14. C (5) | |
| 5. B (2) | 10. D (2) | 15. A (2) | |

Answer explanations for these practice questions are available online. Visit sat.collegeboard.org/practice/biology to view and download the complete document.

Chemistry

Questions cover topics emphasized in most high school courses. Because of course differences, most students will find that there are some questions on topics with which they are not familiar. You may not be able to complete all the questions in the time given, but it is not necessary to get every question correct to get a high score or even the highest score on the test.

Skills Covered in the Context of Chemistry

- Recalling knowledge: remembering fundamental concepts and specific information; demonstrating familiarity with terminology (about 20% of test)
- Applying knowledge of a single principle to unfamiliar and/or practical situations to obtain a qualitative result or solve a quantitative problem (about 45% of test)
- Synthesizing knowledge: inferring and deducing from qualitative and/or quantitative data; integrating two or more relationships to draw conclusions or solve problems (about 35% of test)

Important Things to Note on This Subject Test

- A periodic table indicating the atomic numbers and masses of elements is provided for all test administrations.
- Problem solving requires simple numerical calculations.
- The metric system of units is used.
- Calculator use is not permitted.

Recommended Preparation

- One-year introductory chemistry course at the college-preparatory level
- Laboratory experience — a significant factor in developing reasoning and problem-solving skills — even though this multiple-choice test can only test lab skills in a limited way, as in data analysis
- Mathematics preparation that enables handling simple algebraic relationships and applying these to solving word problems
- Familiarity with the concepts of ratios, direct and inverse proportions, exponents, and scientific notation

| FORMAT/CONTENT | Approximate % of Test |
|--|-----------------------|
| 85 multiple-choice questions | |
| Topics Covered | |
| Structure of Matter | 25% |
| Atomic Structure , including experimental evidence of atomic structure, quantum numbers and energy levels (orbitals), electron configurations, periodic trends | |
| Molecular Structure , including Lewis structures, three-dimensional molecular shapes, polarity | |
| Bonding , including ionic, covalent and metallic bonds; relationships of bonding to properties and structures; intermolecular forces such as hydrogen bonding, dipole-dipole forces, dispersion (London) forces | |
| States of Matter | 16% |
| Gases , including the kinetic molecular theory, gas law relationships, molar volumes, density, stoichiometry | |
| Liquids and Solids , including intermolecular forces in liquids and solids, types of solids, phase changes, and phase diagrams | |
| Solutions , including molarity and percent by mass concentrations, solution preparation and stoichiometry, factors affecting solubility of solids, liquids and gases, qualitative aspects of colligative properties | |
| Reaction Types | 14% |
| Acids and Bases , including Brønsted-Lowry theory, strong and weak acids and bases, pH, titrations, indicators | |
| Oxidation-Reduction , including recognition of oxidation-reduction reactions, combustion, oxidation numbers, use of reduction potentials | |
| Precipitation , including basic solubility rules | |
| Stoichiometry | 14% |
| Mole Concept , including molar mass, Avogadro's number, empirical and molecular formulas | |
| Chemical Equations , including the balancing of equations, stoichiometric calculations, percent yield, and limiting reactants | |
| Equilibrium and Reaction Rates | 5% |
| Equilibrium Systems , including factors affecting position of equilibrium (Le Châtelier's principle) in gaseous and aqueous systems, equilibrium constants, and equilibrium expressions | |
| Rates of Reactions , including factors affecting reaction rates, potential energy diagrams, activation energies | |

(continued)

| FORMAT/CONTENT | Approximate % of Test |
|--|-----------------------|
| Topics Covered | |
| Thermochemistry Including conservation of energy, calorimetry and specific heats, enthalpy (heat) changes associated with phase changes and chemical reactions, heating and cooling curves, entropy | 6% |
| Descriptive Chemistry Including common elements, nomenclature of ions and compounds, periodic trends in chemical and physical properties of the elements, reactivity of elements and prediction of products of chemical reactions, examples of simple organic compounds and compounds of environmental concern | 12% |
| Laboratory Including knowledge of laboratory equipment, measurements, procedures, observations, safety, calculations, data analysis, interpretation of graphical data, drawing conclusions from observations and data | 8% |

Sample Questions

Three types of questions are used in the Chemistry Subject Test: classification questions, relationship analysis questions, and five-choice completion questions. The types are noted below in the practice questions that follow. The directions given are identical to those that are in the test. Relationship analysis questions use a different format, and you will mark your answers to them in a separate section of the answer sheet, as explained in the directions.

Note: For all questions involving solutions, assume that the solvent is water unless otherwise stated.

Directions for Classification Questions

Each set of lettered choices below refers to the numbered statements or questions immediately following it. Select the one lettered choice that best fits each statement or answers each question and then fill in the corresponding circle on the answer sheet. A choice may be used once, more than once, or not at all in each set.

Questions 1-3 refer to the following aqueous solutions.

- (A) 0.1 *M* HCl
- (B) 0.1 *M* NaCl
- (C) 0.1 *M* HC₂H₃O₂
- (D) 0.1 *M* CH₃OH
- (E) 0.1 *M* KOH

1. Is weakly acidic
2. Has the highest pH
3. Reacts with an equal volume of 0.05 *M* Ba(OH)₂ to form a solution with pH = 7

Questions 4-6 refer to the following ionic species.

- (A) X⁺
- (B) X²⁺
- (C) X³⁺
- (D) XO₃²⁻
- (E) XO₄²⁻

4. A type of ion found in sodium acetate
5. A type of ion found in aluminum oxide
6. A type of ion found in potassium phosphate

Questions 7-10 refer to the following atoms in the ground state.

- (A) Ar
- (B) O
- (C) S
- (D) Ti
- (E) U

7. Has the electron configuration 1s² 2s²2p⁶ 3s²3p⁴
8. Has the same number of electrons as Ca²⁺
9. Has electrons in *f* orbitals
10. Is the LEAST chemically reactive

On the actual Chemistry Test, the following type of question must be answered on a special section (labeled "Chemistry") at the lower left-hand corner of your answer sheet. These questions will be numbered beginning with 101 and must be answered according to the following directions.

Sample Answer Grid

*Fill in circle CE (correct explanation) only if statement II is a correct explanation of the true statement I.

| | I | | II | | CE* |
|-----|-----------------------|-----------------------|-----------------------|-----------------------|-----------------------|
| 101 | <input type="radio"/> | <input type="radio"/> | <input type="radio"/> | <input type="radio"/> | <input type="radio"/> |

Directions for Relationship Analysis Questions

Each question below consists of two statements, I in the left-hand column and II in the right-hand column. For each question, determine whether statement I is true or false and whether statement II is true or false and fill in the corresponding T or F circles on your answer sheet. *Fill in circle CE only if statement II is a correct explanation of the true statement I.

- | I | BECAUSE | II |
|--|---------|---|
| 101. The rate at which sugar dissolves in water increases with stirring | | stirring exposes the surface of a solute crystal to a less concentrated layer of solution. |
| 102. Diamond has a high melting point | | in a diamond crystal, the carbon atoms are held in place by ionic bonds. |
| 103. Potassium has a lower first ionization energy than lithium has | | potassium has more protons in its nucleus than lithium has. |
| 104. Zinc metal will reduce Cu^{2+} in solution | | zinc is a more active metal than copper is. |
| $\text{HC}_2\text{H}_3\text{O}_2 + \text{H}_2\text{O} \rightleftharpoons \text{C}_2\text{H}_3\text{O}_2^- + \text{H}_3\text{O}^+$ | | |
| 105. If some acetic acid, $\text{HC}_2\text{H}_3\text{O}_2$, is added to the equilibrium mixture represented by the equation above, the concentration of H_3O^+ decreases | | the equilibrium constant of a reaction changes as the concentration of the reactants changes. |

On the actual Chemistry Test, the remaining questions must be answered by returning to the section of your answer sheet you started for the Chemistry Test

Directions for Five-Choice Completion Questions

Each of the questions or incomplete statements below is followed by five suggested answers or completions. Select the one that is best in each case and then fill in the corresponding circle on the answer sheet.

11. The hydrogen ion concentration of a solution prepared by diluting 50. mL of 0.10 M $\text{HNO}_3(aq)$ with water to 500. mL of solution is
- (A) 0.0010 M (B) 0.0050 M (C) 0.010 M
(D) 0.050 M (E) 1.0 M
- $\dots\text{Cu}^{2+}(aq) + \dots\text{I}^{-}(aq) \rightarrow \dots\text{CuI}(s) + \dots\text{I}_2(s)$
12. When the equation above is balanced and all coefficients are reduced to lowest whole-number terms, the coefficient for $\text{I}^{-}(aq)$ is
- (A) 1 (B) 2 (C) 3
(D) 4 (E) 5

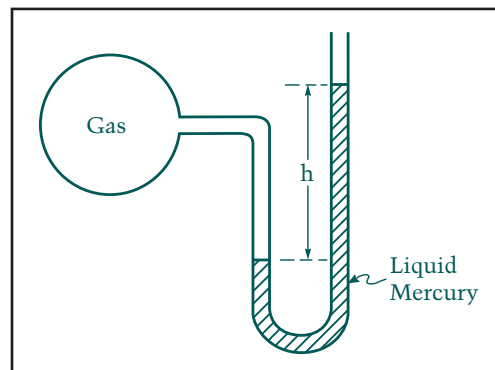

13. The bulb of the open-end manometer shown above contains a gas. True statements about this system include which of the following?
- I. Only atmospheric pressure is exerted on the exposed mercury surface in the right side of the tube.
II. The gas pressure is greater than atmospheric pressure.
III. The difference in the height, h , of mercury levels is equal to the pressure of the gas.
- (A) II only
(B) III only
(C) I and II only
(D) I and III only
(E) I, II, and III

14. A thermometer is placed in a test tube containing a melted pure substance. As slow cooling occurs, the thermometer is read at regular intervals until well after the sample has solidified. Which of the following types of graphs is obtained by plotting temperature *versus* time for this experiment?

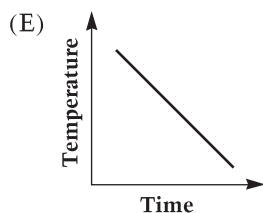
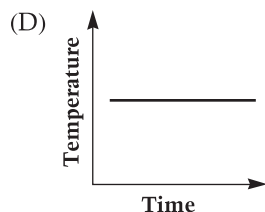
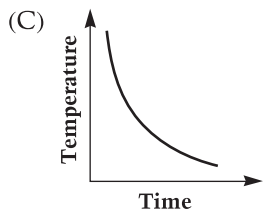
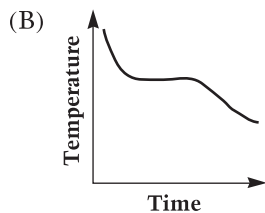
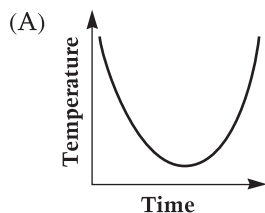

15. From their electron configurations, one can predict that the geometric configuration for which of the following molecules is NOT correct?

- (A) PF_3 trigonal planar
 (B) CF_4 tetrahedral
 (C) CHCl_3 irregular tetrahedron
 (D) OF_2 bent (v-shaped)
 (E) HF linear

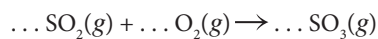

16. According to the reaction represented by the unbalanced equation above, how many moles of $\text{SO}_2(g)$ are required to react completely with 1 mole of $\text{O}_2(g)$?

- (A) 0.5 mol (B) 1 mol (C) 2 mol
 (D) 3 mol (E) 4 mol

17. Analysis by mass of a certain compound shows that it contains 14 percent hydrogen and 86 percent carbon. Which of the following is the most informative statement that can properly be made about the compound on the basis of these data?

- (A) It is a hydrocarbon.
 (B) Its empirical formula is CH_2 .
 (C) Its molecular formula is C_2H_4 .
 (D) Its molar mass is 28 g/mol.
 (E) It contains a triple bond.

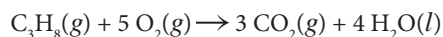

18. The combustion of propane, $\text{C}_3\text{H}_8(g)$, proceeds according to the equation above. How many grams of water will be formed in the complete combustion of 44.0 grams of propane?

- (A) 4.50 g (B) 18.0 g (C) 44.0 g
 (D) 72.0 g (E) 176 g

19. The number of oxygen atoms in 0.50 mole of KHSO_4 is

- (A) 1.2×10^{23}
 (B) 2.4×10^{23}
 (C) 3.0×10^{23}
 (D) 1.2×10^{24}
 (E) 2.4×10^{24}

20. All of the following statements about carbon dioxide are true EXCEPT:

- (A) It can be prepared by the action of acid on limestone.
 (B) It is used to extinguish fires.
 (C) It dissolves in water at room temperature.
 (D) It sublimates rather than melts at 20°C and 1 atmosphere pressure.
 (E) It is less dense than air at a given temperature and pressure.

21. For elements in the left-most column of the periodic table, properties that have increasing values as the atomic number increases include which of the following?

- I. Ionization energy (potential)
 II. Atomic radius
 III. Atomic mass
 (A) I only
 (B) III only
 (C) I and II only
 (D) II and III only
 (E) I, II, and III

22. All of the following can act as Brønsted-Lowry acids (proton donors) in aqueous solution EXCEPT

- (A) HI (B) NH_4^+ (C) HCO_3^-
 (D) H_2S (E) NH_3

ANSWERS

The estimated difficulty level, on a scale of 1 to 5, with 1 the easiest and 5 the most difficult, is in parentheses.

- | | | |
|----------|----------|-----------|
| 1. C (2) | 5. C (1) | 9. E (2) |
| 2. E (3) | 6. A (2) | 10. A (2) |
| 3. A (4) | 7. C (3) | |
| 4. A (3) | 8. A (3) | |

Questions 101–105: See box for difficulty level.

| | I | II | CE | Diff. Level |
|-----|-------|-------|----|-------------|
| 101 | ● (F) | ● (F) | ● | 3 |
| 102 | ● (F) | ⊕ | ○ | 3 |
| 103 | ● (F) | ● (F) | ○ | 3 |
| 104 | ● (F) | ● (F) | ● | 4 |
| 105 | ⊕ | ⊕ | ○ | 5 |

- | | | |
|-----------|-----------|-----------|
| 11. C (3) | 16. C (2) | 21. D (3) |
| 12. D (2) | 17. B (3) | 22. E (4) |
| 13. C (4) | 18. D (2) | |
| 14. B (3) | 19. D (1) | |
| 15. A (3) | 20. E (3) | |

Answer explanations for these practice questions are available online. Visit sat.collegeboard.org/practice/chemistry to view and download the complete document.

Physics

Questions cover topics emphasized in most high school courses. Because of course differences, most students will find that there are some questions on topics with which they are not familiar. You may not be able to complete all the questions in the time given, but it is not necessary to get every question correct to get a high score or even the highest score on the test.

Skills Covered in the Context of Physics

- Recalling and understanding of the major concepts of physics and the application of these physical principles to solve specific problems
 - Fundamental Knowledge: remembering and understanding concepts or information (about 12%–20% of test)
 - Single-Concept Problems: applying a single physical relation or concept (about 48%–64% of test)
 - Multiple-Concept Problems: integrating of two or more physical relationships or concepts (about 20%–35% of test)
- Understanding simple algebraic, trigonometric, and graphical relationships and the concepts of ratio and proportion and the application of these to physics problems
- Application of laboratory skills in the context of the physics content outlined below

Important Things to Note on This Subject Test

- Numerical calculations are not emphasized and are limited to simple arithmetic.
- Questions predominantly use the metric system; pay attention to the units stated.
- You should assume that the direction of any current is the direction of flow of positive charge (conventional current).
- Calculator use is not permitted.

Recommended Preparation

- One-year introductory physics course on the college-preparatory level
- Laboratory experience — a significant factor in developing reasoning and problem-solving skills — even though this test can only measure lab skills in a limited way, such as data analysis

| FORMAT/CONTENT | Approximate % of Test |
|--|-----------------------|
| 75 multiple-choice questions | |
| Topics Covered | |
| Mechanics | 36%–42% |
| Kinematics , such as velocity, acceleration, and motion in one and two dimensions | |
| Dynamics , such as force, Newton's laws, statics, and friction | |
| Energy and Momentum , such as potential and kinetic energy, work, power, impulse, and conservation laws | |

(continued)

| FORMAT/CONTENT | Approximate % of Test |
|--|-----------------------|
| <p>Circular Motion, such as uniform circular motion and centripetal force</p> <p>Simple Harmonic Motion, such as mass on a spring and the pendulum</p> <p>Gravity, such as the law of gravitation, orbits, and Kepler's laws</p> | |
| <p>Electricity and Magnetism</p> <p>Electric Fields, Forces and Potentials, such as Coulomb's law, induced charge, field and potential of groups of point charges, and charged particles in electric fields</p> <p>Capacitance, such as parallel-plate capacitors and time-varying behavior in charging/discharging</p> <p>Circuit Elements and DC Circuits, such as resistors, light bulbs, series and parallel networks, Ohm's law, and Joule's law</p> <p>Magnetism, such as permanent magnets, fields caused by currents, particles in magnetic fields, Faraday's law, and Lenz's law</p> | 18%–24% |
| <p>Waves and Optics</p> <p>General Wave Properties, such as wave speed, frequency, wavelength, superposition, standing waves, and Doppler effect</p> <p>Reflection and Refraction, such as Snell's law and changes in wavelength and speed</p> <p>Ray Optics, such as image formation using pinholes, mirrors, and lenses</p> <p>Physical Optics, such as single-slit diffraction, double-slit interference, polarization, and color</p> | 15%–19% |
| <p>Heat and Thermodynamics</p> <p>Thermal Properties, such as temperature, heat transfer, specific and latent heats, and thermal expansion</p> <p>Laws of Thermodynamics, such as first and second laws, internal energy, entropy, and heat engine efficiency</p> | 6%–11% |
| <p>Modern Physics</p> <p>Quantum Phenomena, such as photoelectric effect and electron diffraction</p> <p>Atomic, such as the Rutherford and Bohr models, atomic energy levels, and atomic spectra</p> <p>Nuclear Physics, such as radioactivity, fission, fusion, and other nuclear processes</p> <p>Relativity, such as time dilation, length contraction, and mass-energy equivalence</p> | 6%–11% |
| <p>Miscellaneous</p> <p>General, such as history of physics and general questions that overlap several major topics</p> <p>Analytical Skills, such as graphical analysis, measurement, and math skills</p> <p>New Topics in Physics, current developments in such areas as astrophysics, elementary particle physics, nanophysics, and new technological applications of physics</p> | 4%–9% |

Sample Questions

Two types of questions are used in the Physics Subject Test: classification questions and five-choice completion questions. Both are noted in the following samples. The directions that follow are identical to those that are in the test. All questions in the test are multiple-choice questions in which you must choose the BEST response from the five choices offered.

Part A

Directions

Each set of lettered choices below refers to the numbered questions immediately following it. Select the one lettered choice that best answers each question and then fill in the corresponding circle on the answer sheet. A choice may be used once, more than once or not at all in each set.

Questions 1-2

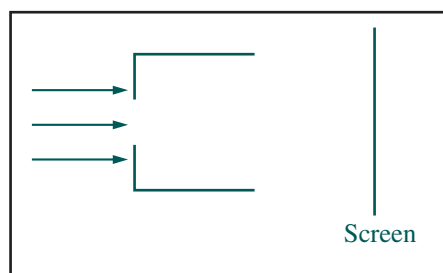

A beam of light is incident on a rectangular opening in the front of a box, as shown in the side view above. The back of the box is open. After passing through the box, the light is incident on a screen. The following devices may be in the box, positioned as shown below.

- (A) A convex lens (B) A concave lens (C) A thick sheet of glass



- (D) An opaque card with a very narrow slit (E) A prism with vertex pointing downward



- Which device could produce a tiny spot of light on the screen?
- Which device could produce a diffraction pattern consisting of a central bright fringe with parallel secondary fringes that decrease in intensity with increasing distance from the center of the screen?

Questions 3-4 relate to a point charge $+Q$ fixed in position, as shown below. Five points near the charge and in the plane of the page are shown.

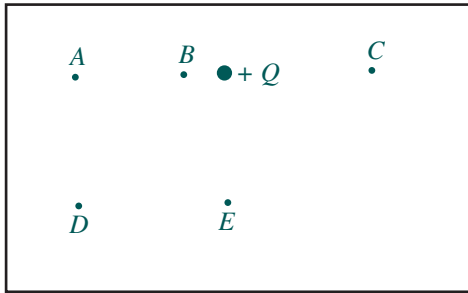

- At which point will the magnitude of the electric field be least?
- At which point will an electron experience a force directed toward the top of the page?

Part B

Directions

Each of the questions or incomplete statements below is followed by five suggested answers or completions. Select the one that is best in each case and then fill in the corresponding circle on the answer sheet.

- When a vector of magnitude 6 units is added to a vector of magnitude 8 units, the magnitude of the resultant vector will be
 - exactly 2 units
 - exactly 10 units
 - exactly 14 units
 - 0 units, 10 units, or some value between them
 - 2 units, 14 units, or some value between them

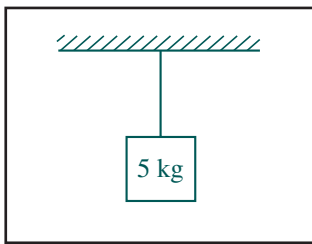

- A 5-kilogram block is suspended by a cord from the ceiling, as shown above. The force exerted on the block by the cord is most nearly
 - zero
 - 25 N
 - 50 N
 - 100 N
 - 200 N

- An experiment is performed to measure the specific heat of copper. A lump of copper is heated in an oven, then dropped into a beaker of water. To calculate the specific heat of copper, the experimenter must know or measure the value of all of the quantities below EXCEPT the
 - mass of the water
 - original temperatures of the copper and the water
 - final (equilibrium) temperature of the copper and the water
 - time taken to achieve equilibrium after the copper is dropped into the water
 - specific heat of the water

- Which of the following graphs best represents the kinetic energy K of an elementary particle as a function of its speed v , where c is the speed of light?
 -
 -
 -
 -
 -

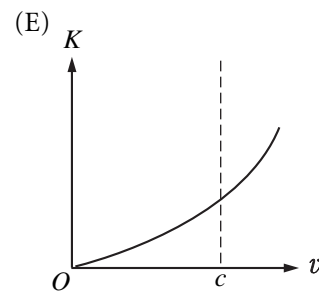
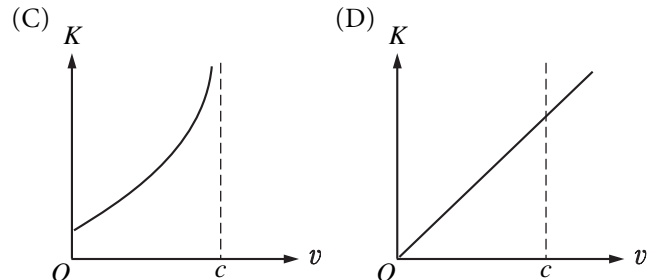
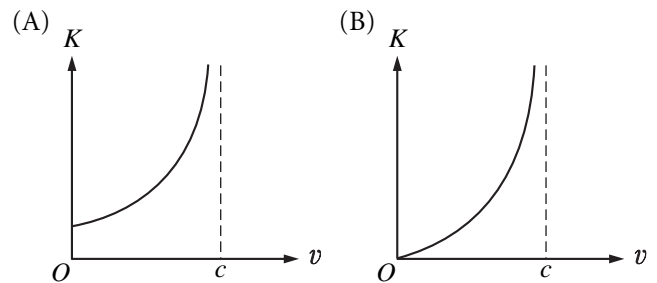

- In a given process, 12 joules of heat is added to an ideal gas and the gas does 8 joules of work. Which of the following is true about the internal energy of the gas during this process?
 - It has increased by 20 joules.
 - It has increased by 4 joules.
 - It has not changed.
 - It has decreased by 4 joules.
 - It has decreased by 20 joules.

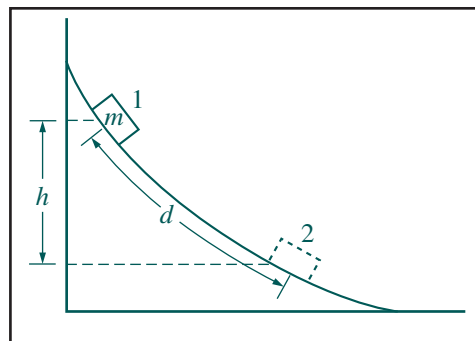
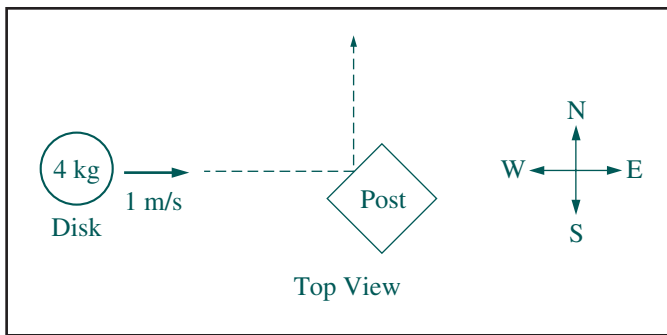

10. A 4-kilogram disk slides over level ice toward the east at a velocity of 1 meter per second, as shown above. The disk strikes a post and rebounds toward the north at the same speed. The change in the magnitude of the eastward component of the momentum of the disk is

- (A) $-4 \text{ kg} \cdot \text{m/s}$
- (B) $-1 \text{ kg} \cdot \text{m/s}$
- (C) $0 \text{ kg} \cdot \text{m/s}$
- (D) $1 \text{ kg} \cdot \text{m/s}$
- (E) $4 \text{ kg} \cdot \text{m/s}$

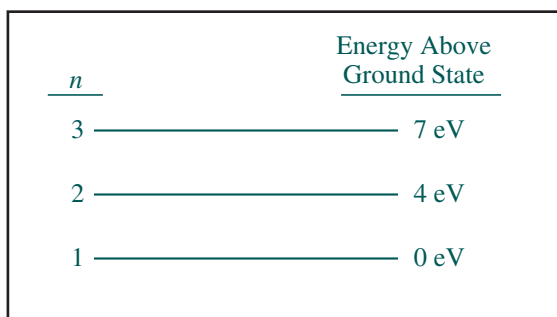

11. Three energy levels of an atom are shown above. Atoms in the $n = 2$ state can spontaneously emit photons having which of the following energies?

- (A) 4 eV only
- (B) 7 eV only
- (C) 3 eV and 4 eV only
- (D) 3 eV and 7 eV only
- (E) 3 eV, 4 eV, and 7 eV

12. A box of mass m is released from rest at position 1 on the frictionless curved track shown above. It slides a distance d along the track in time t to reach position 2, dropping a vertical distance h . Let v and a be the instantaneous speed and instantaneous acceleration, respectively, of the box at position 2. Which of the following equations is valid for this situation?

- (A) $h = vt$
- (B) $h = \frac{1}{2}gt^2$
- (C) $d = \frac{1}{2}at^2$
- (D) $v^2 = 2ad$
- (E) $mgh = \frac{1}{2}mv^2$

Questions 13-14 relate to the following circuit.

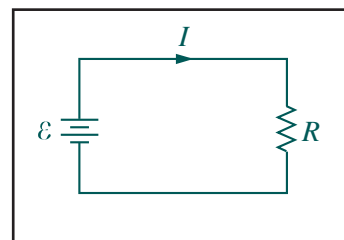

A single resistor R is connected to a battery as shown above. The current is I and the power dissipated as heat is P . The circuit is changed by doubling the emf \mathcal{E} of the battery while R is kept constant.

13. After the change, the current is

- (A) $\frac{I}{4}$
- (B) $\frac{I}{2}$
- (C) I
- (D) $2I$
- (E) $4I$

14. After the change, the power dissipated in R is

- (A) $\frac{P}{4}$
- (B) $\frac{P}{2}$
- (C) P
- (D) $2P$
- (E) $4P$

15. Which of the following is true of the magnetic field produced by a current in a long, straight wire?
- (A) The field is uniform.
 - (B) The field increases in strength as the distance from the wire increases.
 - (C) The field lines are directed parallel to the wire, but opposite to the direction of the current.
 - (D) The field lines are directed radially outward from the wire.
 - (E) The field lines form circles about the wire.
16. The Earth has a radius of 6,400 kilometers. A satellite orbits the Earth at a distance of 12,800 kilometers from the center of the Earth. If the weight of the satellite on Earth is 100 kilonewtons, the gravitational force on the satellite in orbit is
- (A) 11 kilonewtons
 - (B) 25 kilonewtons
 - (C) 50 kilonewtons
 - (D) 100 kilonewtons
 - (E) 200 kilonewtons
17. A pendulum of length ℓ with a bob of mass m is oscillating with small amplitude. Which of the following changes in the pendulum would double its period?
- (A) Doubling the mass m of the bob
 - (B) Doubling the initial force used to set the pendulum in motion
 - (C) Doubling the amplitude of the pendulum's swing
 - (D) Quadrupling the mass m of the bob
 - (E) Quadrupling the length ℓ of the pendulum

Questions 18-19

A piece of chalk is thrown vertically upward and caught during its descent at the same height from which it was thrown. Position is measured from the location of the chalk when it left the hand. The positive direction for position, velocity, and acceleration is upward.

18. What are the signs of the position, velocity, and acceleration during the ascending part of the trajectory?

| | <u>POSITION</u> | <u>VELOCITY</u> | <u>ACCELERATION</u> |
|-----|-----------------|-----------------|---------------------|
| (A) | Positive | Positive | Positive |
| (B) | Positive | Positive | Negative |
| (C) | Positive | Negative | Negative |
| (D) | Negative | Positive | Negative |
| (E) | Negative | Negative | Negative |

19. What are the signs of the position, velocity, and acceleration during the descending part of the trajectory?

| | <u>POSITION</u> | <u>VELOCITY</u> | <u>ACCELERATION</u> |
|-----|-----------------|-----------------|---------------------|
| (A) | Positive | Positive | Positive |
| (B) | Positive | Positive | Negative |
| (C) | Positive | Negative | Negative |
| (D) | Negative | Positive | Negative |
| (E) | Negative | Negative | Negative |

ANSWERS

The estimated difficulty level, on a scale of 1 to 5, with 1 the easiest and 5 the most difficult, is in parentheses.

| | | | |
|---------|----------|----------|----------|
| 1. A(3) | 7. D(3) | 13. D(3) | 19. C(5) |
| 2. D(3) | 8. B(2) | 14. E(5) | |
| 3. D(1) | 9. B(3) | 15. E(3) | |
| 4. E(2) | 10. A(4) | 16. B(5) | |
| 5. E(2) | 11. A(4) | 17. E(4) | |
| 6. C(1) | 12. E(4) | 18. B(4) | |

Answer explanations for these practice questions are available online. Visit sat.collegeboard.org/practice/physics to view and download the complete document.

Chinese with Listening

Questions cover topics emphasized in most high school courses. Because of course differences, most students will find that there are some questions on topics with which they are not familiar. You may not be able to complete all the questions in the time given, but it is not necessary to get every question correct to get a high score or even the highest score on the test.

Remember to bring an acceptable CD player and fresh batteries with you on test day. See page 3 for more information.

Skills Covered in the Context of the Chinese Language

Listening Comprehension: These questions test the ability to understand the spoken language and are based on short, spoken dialogues and narratives primarily about everyday topics. There are two different kinds of listening comprehension questions: (A) a spoken statement, question or exchange, followed by a choice of three possible responses (also spoken); (B) a spoken dialogue or monologue with a printed question or questions (in English) about what was said.

Usage: These questions ask you to select the answer that best completes a Chinese sentence in a way that is structurally and logically correct. Questions are written to reflect instructional practices of the curriculum. This section of the test is therefore presented in four columns across two pages of the test booklet to allow each question and its answer choices to be shown in four different ways of representing Chinese: traditional and simplified Chinese characters on the left page, and phonetic transcriptions in Pinyin romanization and the Chinese phonetic alphabet (Bopomofo) on the right page. You should choose the writing form with which you are most familiar and read only from that column.

Reading Comprehension: Reading comprehension questions test your understanding of such points as main and supporting ideas, themes, and the setting of passages. Some of the passages are based on real-life materials such as timetables, forms, advertisements, notes, letters, diaries, and newspaper articles. All passages are written in both traditional and simplified Chinese characters. Most questions deal with understanding of literal meaning, although some inference questions may be included. All reading comprehension questions are in English.

Recommended Preparation

- Three to four years of Mandarin Chinese language study in high school or the equivalent
- Gradual development of competence in Chinese over a period of years
- Review sample listening questions using an SAT Subject Test Practice CD that your counselor can order from the College Board

| FORMAT/CONTENT | Approximate % of Test |
|---------------------------------------|-----------------------|
| 85 multiple-choice questions | |
| Skills Measured | |
| Listening Section (20 minutes) | |
| Listening comprehension | 33% |
| Reading Section (40 minutes) | |
| Usage | 33% |
| Reading comprehension | 33% |

Sample Listening Questions

All questions in the test are multiple choice. You must choose the BEST response from the three or four choices offered for each question.

When the test is administered, all spoken Chinese will be presented by CD playback. All text appearing here in square brackets [] is spoken.

Part A

Directions

(Narrator): [Directions: In this part of the test you will hear short questions, statements or commands in Mandarin Chinese, followed by three responses in Mandarin Chinese, designated (A), (B) and (C). You will hear the questions or statements, as well as the responses, just one time, and they are not printed in your test booklet. Therefore you must listen very carefully. Select the best response and fill in the corresponding circle on your answer sheet.]

Question 1

(Narrator) [Number 1.

(Man) 今天天氣怎麼樣？

(Woman) (A) 我很好，謝謝。

(B) 星期天不行。

(C) 可能會很冷。] (5 seconds)

Question 2

(Narrator) [Number 2.

(Man) 我馬上就要畢業了。

(Woman) (A) 恭喜你。

(B) 太客氣。

(C) 也好看。] (5 seconds)

Question 3

(Narrator) [Number 3.

(Man) 這本書貴不貴?

(Woman) 不貴，也不便宜。

(Man) (A) 多久了?
(B) 多少錢?
(C) 多不多?] (5 seconds)

Question 4

(Narrator) [Number 4.

(Woman) 我們今天應該用鉛筆還是用鋼筆?

(Man) 用鉛筆。你帶來了嗎?

(Woman) (A) 鋼筆比鉛筆貴。
(B) 這枝毛筆很好用。
(C) 兩種筆我都帶了。] (5 seconds)

Part B

Directions

(Narrator): [Directions: You will now hear a series of short selections. You will hear them only once, and they are not printed in your test booklet. After each selection, you will be asked to answer one or more questions about what you have just heard. These questions, each with four possible answers, are printed in your test booklet. Select the best answer to each question from among the four choices given and fill in the corresponding circle on your answer sheet. You will have 15 seconds to answer each question.]

Questions 5-6

(Narrator) [Questions 5 and 6. Listen to find out what the woman will do next summer.

(Woman) 你去過香港嗎?

(Man) 沒去過，可是我明年夏天從日本到中國去的時候會經過香港。

(Woman) 明年夏天，我得留在美國上暑期班，哪兒都不能去。

(Narrator) Now answer questions 5 and 6.] (30 seconds)

5. Where will the woman spend the summer next year?

- (A) In China
- (B) In Japan
- (C) In Hong Kong
- (D) In the United States

6. What will the woman do?

- (A) Visit friends
- (B) Go to school
- (C) Look for a job
- (D) Travel abroad

Question 7

(Narrator) [Question 7. Listen to find out what the tour guide is telling the group of tourists.

(Woman) 請大家注意：友誼商店到了，現在是十點鐘，不要忘了我們十一點鐘在這兒上車，去美術館。

(Narrator) Now answer question 7.] (15 seconds)

7. What will the tourists most likely do after the announcement?

- (A) Claim their luggage
- (B) Go shopping
- (C) Call a taxi
- (D) Leave the art museum

Sample Usage Questions

Directions: This section consists of a number of incomplete statements, each of which has four possible completions. Select the word or phrase that best completes the sentence structurally and logically and fill in the corresponding circle on your answer sheet.

This section of the test is presented in four columns across two pages to allow each item to be shown in four different ways of representing Chinese: traditional characters, simplified characters, pinyin romanization, and the Chinese phonetic alphabet (Bopomofo). TO SAVE TIME, IT IS RECOMMENDED THAT YOU CHOOSE THE WRITING FORM WITH WHICH YOU ARE MOST FAMILIAR AND **READ ONLY FROM THAT COLUMN** AS YOU WORK THROUGH THIS SECTION OF THE TEST.

8. 我很喜歡這部電影。你 ____ ?

- (A) 啊
- (B) 嗎
- (C) 吧
- (D) 呢

8. 我很喜欢这部电影。你 ____ ?

- (A) 啊
- (B) 吗
- (C) 吧
- (D) 呢

9. 我從來沒吃 ____ 這麼好吃的菜。

- (A) 得
- (B) 過
- (C) 給
- (D) 成

9. 我从来没吃 ____ 这么好吃的菜。

- (A) 得
- (B) 过
- (C) 给
- (D) 成

10. ____ 我哥哥比我大五歲，
____ 我比哥哥高得多。

- (A) 雖然 可是
- (B) 因為 所以
- (C) 既然 就
- (D) 就是 也

10. ____ 我哥哥比我大五岁，
____ 我比哥哥高得多。

- (A) 虽然 可是
- (B) 因为 所以
- (C) 既然 就
- (D) 就是 也

11. 星期天我要在家休息， ____。

- (A) 不去都哪兒
- (B) 都哪兒不去
- (C) 不去哪兒都
- (D) 哪兒都不去

11. 星期天我要在家休息， ____。

- (A) 不去都哪儿
- (B) 都哪儿不去
- (C) 不去哪儿都
- (D) 哪儿都不去

8. Wǒ hěn xǐhuan zhèi bù diànyǐng. Nǐ ____ ?

- (A) a
- (B) ma
- (C) ba
- (D) ne

8. 我 很 喜 欢 这 部 电 影 。 你 ____ ?

- (A) 呀
- (B) 吗
- (C) 呢
- (D) 吧

9. Wǒ cónglái méi chī ____ zhème hǎochī de cài.

- (A) de
- (B) guo
- (C) gěi
- (D) chéng

9. 我 从 来 没 有 吃 过 这 么 好 吃 的 菜 。

- (A) 过
- (B) 吃
- (C) 给
- (D) 成

10. ____ wǒ gēge bǐ wǒ dà wǔ suì,
____ wǒ bǐ gēge gāo de duō.

- (A) Suīrán kěshì
- (B) Yīnwei suǒyǐ
- (C) Jìrán jiù
- (D) Jiùshì yě

10. ____ 我 哥 哥 比 我 大 五 岁 ，
____ 我 比 哥 哥 高 的 多 。

- (A) 虽 然 可 是
- (B) 因 为 所 以
- (C) 既 然 就
- (D) 既 使 也

11. Xīngqītiān wǒ yào zài jiā xiūxi, ____ .

- (A) bú qù dōu nǎr
- (B) dōu nǎr bú qù
- (C) bú qù nǎr dōu
- (D) nǎr dōu bú qù

11. 星 期 天 我 要 在 家 休 息 ， ____ 。

- (A) 不 去 哪 儿
- (B) 哪 儿 不 去
- (C) 不 去 哪 儿 又
- (D) 哪 儿 又 不 去

Sample Reading Questions

Questions 12-13

老王：

李平剛才打電話來說他病了，
今天不能來上課。請你幫他代課。

小陳

老王：

李平剛才打電話來說他病了，
今天不能來上課。請你幫他代課。

小陳

12. This note tells us that

- (A) Wang is a teacher and Li is a student
- (B) Wang is a teacher and Chen is a student
- (C) Wang and Li are both teachers
- (D) Li and Chen are both students

13. Who called in sick?

- (A) Wang
- (B) Chen
- (C) Lin
- (D) Li

Questions 14-15

亞洲航空公司四月五日
宣佈，因暑期旅客增多，所
以計劃增加飛往美國各大城
市的班機。將於今年六月十五
日至八月二十日之間，每逢星
期一、二、四、五、六增加班
機往返紐約、香港。每週五次。

亞洲航空公司四月五日
宣布，因暑期旅客增多，所
以计划增加飞往美国各大城
市的班机。將於今年六月十五
日至八月二十日之间，每逢星
期一、二、四、五、六增加班
机往返纽约、香港。每周五次。

14. This advertisement is announcing a temporary offer of

- (A) additional destinations
- (B) lower fares
- (C) special discounts
- (D) additional flights

15. When does this offer become effective?

- (A) August 20
- (B) June 15
- (C) April 5
- (D) February 1

ANSWERS

The estimated difficulty level, on a scale of 1 to 5, with 1 the easiest and 5 the most difficult, is in parentheses.

- | | | | |
|----------|----------|-----------|-----------|
| 1. C (2) | 5. D (3) | 9. B (2) | 13. D (3) |
| 2. A (2) | 6. B (4) | 10. A (3) | 14. D (5) |
| 3. B (1) | 7. B (3) | 11. D (4) | 15. B (4) |
| 4. C (3) | 8. D (1) | 12. C (4) | |

Answer explanations for these practice questions are available online. Visit sat.collegeboard.org/practice/chinese to view and download the complete document.

French and French with Listening

Questions cover topics emphasized in most high school courses. Because of course differences, most students will find that there are some questions on topics with which they are not familiar. You may not be able to complete all the questions in the time given, but it is not necessary to get every question correct to get a high score or even the highest score on the test.

If you are taking the French with Listening Test, remember to bring an acceptable CD player and fresh batteries with you on test day. See page 3 for more information.

Skills Covered in the Context of the French Language

Precision of Vocabulary: These questions test knowledge of words representing different parts of speech and some basic idioms within culturally authentic contexts.

Structure: These questions measure the ability to select an appropriate word or expression that is grammatically correct within a sentence. One part of the test contains vocabulary and structure questions embedded in longer paragraphs.

Reading Comprehension: These questions test understanding of such points as main and supporting ideas, themes, and setting of a passage. Selections are drawn from fiction, essays, historical works, and newspaper articles or everyday materials such as advertisements, timetables, forms, and tickets.

The French with Listening Test also measures the ability to understand spoken language with three types of *listening* questions:

Type One: Identify the sentence that most accurately describes what is presented in a picture or photograph.

Type Two: Answer general content questions based on short dialogues or monologues.

Type Three: Answer more specific questions based on longer dialogues or monologues.

Recommended Preparation

Both tests reflect general trends in high school curricula and are independent of particular textbooks or methods of instruction. Recommended preparation includes:

- Three to four years study in high school or the equivalent, or two years of strong preparation
- Gradual development of competence in French over a period of years
- Review sample listening questions using an SAT Subject Test Practice CD that your counselor can order from the College Board, if you are taking the French with Listening Test.

FORMAT/CONTENT — FRENCH

Approximate
% of Test

85 multiple-choice questions

Skills Measured

| | |
|-----------------------|---------|
| Vocabulary in context | 30% |
| Structure | 30%–40% |
| Reading comprehension | 30%–40% |

FORMAT/CONTENT — FRENCH with LISTENING

Approximate
% of Test

85–90 multiple-choice listening and reading questions

Listening Section (20 minutes)

35%

| | |
|-----------------|-----------------|
| Pictures | 8–12 questions |
| Short dialogues | 6–12 questions |
| Long dialogues | 10–15 questions |

Reading Section (40 minutes)

65%

| | |
|-----------------------|-----------------|
| Vocabulary | 16–20 questions |
| Structure | 16–20 questions |
| Reading comprehension | 20–25 questions |

Sample Reading Questions

Four types of reading questions are used in the French Subject Tests. All questions in the tests are multiple-choice questions in which you must choose the BEST response from the four choices offered.

Part A

Directions

This part consists of a number of incomplete statements, each having four suggested completions. Select the most appropriate completion and fill in the corresponding circle on the answer sheet.

1. Pourquoi es-tu debout si ... puisque tu dois te lever de bonne heure?
(A) tard (B) loin (C) peu (D) haut
2. Je ne pleure pas! J'ai quelque chose dans ...
(A) l'oeuvre (B) l'outil (C) l'oreiller (D) l'oeil
3. Les diplomates ont négocié un ... entre les deux pays.
(A) traitement (B) accord
(C) agrément (D) concombre

Part B

Directions

Each of the following sentences contains a blank. From the four choices given, select the one that can be inserted in the blank to form a grammatically correct sentence and fill in the corresponding circle on the answer sheet. Choice (A) may consist of dashes that indicate that no insertion is required to form a grammatically correct sentence.

4. À cette occasion Jean-Louis a mis ----- plus belle chemise et une jolie cravate neuve.
(A) sa (B) son (C) ses (D) sienne
5. Si tu faisais du jogging tous les jours, est-ce que tu te ----- mieux?
(A) sentiras (B) sentirais (C) sentais (D) sens
6. — ----- est sur la table?
— C'est le vin que ta mère a commandé.
(A) Quoi (B) Qu'est-ce qu'
(C) Quel (D) Qu'est-ce qui
8. (A) consommant
(B) consommé
(C) avoir consommé
(D) consommer
9. (A) légumes
(B) fleurs
(C) poisons
(D) fruits
10. (A) ceux
(B) lesquels
(C) quels
(D) leurs
11. (A) indifférents
(B) repentants
(C) prudents
(D) reconnaissants

Part C

Directions

The paragraph below contains blank spaces indicating omissions in the text. For some blanks it is necessary to choose the completion that is most appropriate to the meaning of the passage; for other blanks, to choose the one completion that forms a grammatically correct sentence. In some instances, choice (A) may consist of dashes that indicate that no insertion is required to form a grammatically correct sentence. In each case, indicate your answer by filling in the corresponding circle on the answer sheet. Be sure to read the paragraph completely before answering the questions related to it.

- Selon (7), les Français célèbrent les fêtes de fin d'année en (8) un bon nombre d'huitres et d'autres (9) de mer. Ils offrent de petits cadeaux à (10) envers qui ils sont (11). Et ils envoient des (12) de vœux à (13) amis et collègues.
7. (A) la coutume
(B) l'utilisation
(C) l'habit
(D) le temps
12. (A) cartons
(B) photos
(C) cartes
(D) feuilles
13. (A) ses
(B) tous
(C) leurs
(D) mes

Part D

Directions

Read the following selections carefully for comprehension. Each selection is followed by a number of questions or incomplete statements. Select the completion or answer that is BEST according to the selection and fill in the corresponding circle on the answer sheet.

- Alors, que dire des contes qu'invente aujourd'hui la publicité? On dénonce l'artifice et les conventions des messages publicitaires. Mais quand on demande à des enfants de choisir entre divers scénarios ou types d'illustration, il faut bien constater que ce sont justement ces conventions, cet artifice qu'ils préfèrent. Les parents s'inquiètent des images de violence physique ou de complaisance sexuelle qu'on peut voir à la télévision, alors que les enfants, au moins jusqu'à la puberté, y sont en général indifférents. En revanche, ils détestent le journal télévisé. Avec son cortège de guerres, de chômage et de grèves, de drames et de catastrophes, il les met mal à l'aise. La publicité, avec son imagerie du bonheur, les rassure.
- (5) Et quand les moralistes reprochent aux publicitaires de lier cette idée de bonheur à la possession de biens matériels, ils oublient que les contes de fées non plus n'étaient pas désintéressés. Ce n'est pas le problème des enfants. Cela peut être celui des parents, quand ils s'efforcent de leur apprendre à faire le départ entre le réel et l'imaginaire, entre le désir et sa réalisation.
14. Selon l'article, les effets des scènes de violence et de complaisance sexuelle à la télévision sur les jeunes enfants sont en général
- (A) nuisibles (B) graves
(C) favorables (D) insignifiants
15. D'après le texte, quelle est la réaction que le journal télévisé provoque chez les enfants?
- (A) Il les trouble. (B) Il les intéresse.
(C) Il les laisse indifférents. (D) Il les rassure.
16. Quelle est la conclusion de l'article vis-à-vis de la publicité?
- (A) La réaction des enfants devant la publicité dépend des parents.
(B) Tous les enfants réagissent différemment à la publicité.
(C) La publicité est salutaire dans le développement de l'enfant.
(D) On a raison de dénoncer les messages publicitaires.



LE BON MOMENT
— PAR LES RESTAURATEURS —
DU VOYAGE

La SNCF et ses restaurateurs, s'engagent par un service de qualité, à vous faire passer un bon moment pendant le temps de votre voyage. Pour être sûr de pouvoir en profiter, la SNCF vous recommande de réserver votre repas en même temps que votre place.

17. Quand on voyage en train, on devrait réserver une table au moment où l'on
- (A) achète son billet
(B) commence le voyage
(C) annonce le repas
(D) arrive à destination

Sample Listening Questions

The following three types of questions appear on the French Test with Listening. All questions in this section of the test are multiple-choice questions in which you must choose the BEST response from three or four choices offered. Text in brackets [] is recorded on the CD.

Part A

Directions

For each item in this part, you will hear four sentences designated (A), (B), (C), and (D). They will not be printed in your test booklet. As you listen, look at the picture in your test booklet and select the choice that best reflects what you see in the picture or what someone in the picture might say. Then fill in the corresponding circle on the answer sheet. You will hear the choices only once. Now look at the following example.

You see:

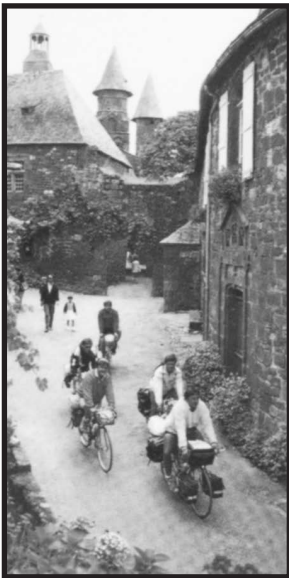

You hear:

- [(A) Quelle joie d'être seul!
- (B) Que c'est agréable de faire du vélo!
- (C) Le moteur fait trop de bruit!
- (D) Nous adorons la course à pied.]

Statement (B), "Que c'est agréable de faire du vélo!" best reflects what you see in the picture or what someone in the picture might say. Therefore, you should choose answer (B).

1. You see:



You hear:

[Numéro 1
(Woman)

- (A) Il y a beaucoup de vagues cet après-midi.
- (B) Quel plaisir d'être en forêt!
- (C) Faire de la voile est bien agréable.
- (D) Les bateaux à rames sont lents et silencieux.]

(7 seconds)

2. You see:



You hear:

[Numéro 2
(Man)

- (A) C'est bien, la musique en plein air!
- (B) Ces gens écoutent un discours passionnant.
- (C) Ces gens se plaignent du bruit.
- (D) Cette salle de concert a une bonne acoustique.]

(7 seconds)

Part B

Directions

In this part of the test you will hear several short selections. A tone will announce each new selection. The selections will not be printed in your test booklet, and will be heard only once. At the end of each selection, you will be asked one or two questions about what was said, each followed by three possible answers, (A), (B), and (C). The answers are not printed in your test booklet. You will hear them only once. Select the BEST answer and fill in the corresponding circle on the answer sheet. Now listen to the following example, but do not mark the answer on your answer sheet.

You hear:

[(Tone)]

(Man B) Papa, ta voiture est chez le garagiste.

(Man A) Mais pourquoi? Elle a toujours bien marché.

(Man B) Euh, en réalité, j'ai eu un accident.

(Man A) Quoi? Tu plaisantes, n'est-ce pas?

(Woman A) Qu'est-ce qu'on peut dire de la voiture en question?

- (A) Elle est en réparation.
- (B) Elle est sur la route.
- (C) Elle est chez un ami.]

The best answer to the question, "Qu'est-ce qu'on peut dire de la voiture en question?" is (A), "Elle est en réparation." Therefore, you should choose answer (A).

Questions 3-4

[(Tone)]

(Woman A) Agence Beausoleil, bonjour.

(Man A) Bonjour, madame. Pourriez-vous m'aider à trouver un vol pour Toronto dans la semaine du 15 avril?

(Woman A) Bien sûr, monsieur. Selon l'ordinateur, il y a des vols à 11 heures et à 15 heures tous les jours.

(Man A) D'accord. Réservez-moi une place sur le vol de 11 heures, pour le mardi 16.

(Woman A) Entendu, monsieur.]

(5 seconds)

3. [Numéro 3]

(Woman A) Qu'est-ce que le monsieur veut faire?

- (A) Réserver une chambre
- (B) Acheter un ordinateur
- (C) Prendre un avion]

(7 seconds)

4. [Numéro 4]

(Woman A) Quand le monsieur va-t-il partir?

- (A) Immédiatement
- (B) En semaine
- (C) Pendant le week-end]

(7 seconds)

Questions 5-6

[(Tone)]

(Man A) Pour la quatrième année consécutive, des échanges auront lieu entre des étudiants de Paris et de New York. Environ vingt-cinq étudiants âgés de 15 à 17 ans viendront passer trois semaines dans des familles aux États-Unis. L'été suivant, ce sera le tour des étudiants américains d'être hébergés dans des familles françaises.]

(5 seconds)

5. [Numéro 5]

(Man B) Quel est le but de cette annonce à la radio?

- (A) D'encourager le tourisme en été
- (B) De présenter des renseignements sur Paris
- (C) De présenter un programme d'échange]

(7 seconds)

6. [Numéro 6]

(Man B) Combien de temps doit durer ce séjour?

- (A) Trois semaines
- (B) Six mois
- (C) Un an]

(7 seconds)

Questions 7-8

[(Tone)

(Man A) Bon, c'est d'accord. Nous allons d'abord voir un film, puis retrouver Anne et Sophie au café de la gare. On se rencontre à dix-neuf heures devant le cinéma, entendu?

(Man B) C'est ça. À ce soir.]

(5 seconds)

7. [Numéro 7

(Woman A) Qu'est-ce que les deux amis vont faire ensemble?

- (A) Prendre le train
- (B) Aller au cinéma
- (C) Écouter des disques]

(7 seconds)

8. [Numéro 8

(Woman A) Où les amis vont-ils rencontrer Anne et Sophie?

- (A) Chez elles
- (B) Dans un café
- (C) Au théâtre]

(7 seconds)

Part C

Directions

You will now hear some extended dialogues or monologues. You will hear each only once. After each dialogue or monologue, you will be asked several questions about what you have just heard. These questions are also printed in your test booklet. Select the best answer to each question from among the four choices printed in your test booklet and fill in the corresponding circle on the answer sheet. There is no sample question for this part.

Questions 9-11

You will hear:

[(Man A) Dialogue numéro 1. Éric, jeune étudiant demeurant à Paris, parle de ses activités.

(Woman A) Alors, dis-moi ce que tu fais.

(Man B) Je suis chanteur dans deux groupes, un de Rythme & Blues, et un autre groupe, un groupe de rock.

(Woman A) Et vous répétez souvent?

(Man B) Pour le groupe de Rythme & Blues, nous répétons pas souvent; nous avons répété pendant huit mois et donc nous connaissons assez bien le

répertoire et je ne fais pas tous les concerts avec eux, donc ce n'est pas la peine.

(Woman A) Et comment s'appelle ce groupe?

(Man B) Ce groupe s'appelle *Les Steady Holy Men*.

(Woman A) Et l'autre groupe?

(Man B) C'est un groupe de rock qui s'appelle *Riffraff* et là, on vient de commencer il y a deux mois, un peu plus peut-être, et nous répétons, une fois par semaine au moins, quelquefois deux fois par semaine, pendant trois ou quatre heures.

(Woman A) Et vous répétez où?

(Man B) Nous répétons dans un local de répétitions. Il y en a plusieurs sur Paris où on peut payer à l'heure pour répéter dans un studio. Tout est équipé.

(Woman A) Bien, et vous jouez où, en général?

(Man B) Nous jouons dans des bars, dans des clubs, dans des bistros, dans des caves.]

9. [Numéro 9

(Woman B) Au cours de cette conversation, qu'est-ce que nous apprenons sur le jeune Éric?]

Au cours de cette conversation, qu'est-ce que nous apprenons sur le jeune Éric?

- (A) Il est chanteur.
- (B) Il a terminé ses études.
- (C) Il est acteur.
- (D) Il veut apprendre le français.

(12 seconds)

10. [Numéro 10

(Woman B) Pourquoi les membres du groupe Rythme & Blues ne répètent-ils pas souvent?]

Pourquoi les membres du groupe Rythme & Blues ne répètent-ils pas souvent?

- (A) Parce qu'ils connaissent bien les chansons
- (B) Parce qu'ils aiment improviser
- (C) Parce qu'ils s'intéressent à d'autres concerts
- (D) Parce qu'ils jouent rarement en public

(12 seconds)

11. [Numéro 11

(Woman B) Qu'est-ce qu'Éric dit à propos du local de répétitions?]

Qu'est-ce qu'Éric dit à propos du local de répétitions?

- (A) On doit apporter son propre équipement.
- (B) On doit connaître le propriétaire du local.
- (C) On peut louer un studio à l'heure.
- (D) On peut y répéter seulement le week-end.

(12 seconds)

ANSWERS

The estimated difficulty level, on a scale of 1 to 5, with 1 the easiest and 5 the most difficult, is in parentheses.

Reading Questions

- | | | | |
|----------|-----------|-----------|-----------|
| 1. A (1) | 6. D (4) | 11. D (3) | 16. A (3) |
| 2. D (2) | 7. A (2) | 12. C (3) | 17. A (3) |
| 3. B (3) | 8. A (2) | 13. C (2) | |
| 4. A (2) | 9. D (2) | 14. D (3) | |
| 5. B (3) | 10. A (5) | 15. A (4) | |

Listening Questions

- | | | | |
|----------|----------|----------|-----------|
| 1. D (4) | 4. B (2) | 7. B (2) | 10. A (4) |
| 2. A (3) | 5. C (2) | 8. B (3) | 11. C (3) |
| 3. C (2) | 6. A (3) | 9. A (2) | |

Answer explanations for these practice questions are available online. Visit sat.collegeboard.org/practice/french to view and download the complete document.

German and German with Listening

Questions cover topics emphasized in most high school courses. Because of course differences, most students will find that there are some questions on topics with which they are not familiar. You may not be able to complete all the questions in the time given, but it is not necessary to get every question correct to get a high score or even the highest score on the test.

If you are taking the German with Listening Test, remember to bring an acceptable CD player and fresh batteries with you on test day. See page 3 for more information.

Skills Covered in the Context of the German Language

Sentence Completion and Paragraph Completion: These questions test vocabulary and grammar, requiring you to know the meaning of words and idiomatic expressions in context and to identify usage that is structurally correct and appropriate.

Reading Comprehension: These questions test understanding of the content of various materials taken from sources such as advertisements, timetables, street signs, forms, and tickets. They also examine your ability to read passages representative of various styles and levels of difficulty. There are several prose passages followed by questions that test your understanding of the passages. The passages, mostly adapted from literary sources and newspapers or magazines, are generally one or two paragraphs in length and test whether you can identify the main idea or comprehend facts or details in the text.

Both German Subject Tests comply with the German spelling reform (Rechtschreibreform) as much as possible.

The German with Listening Test also measures the ability to understand spoken language with two types of listening questions:

Type One: Contains short dialogues/monologues with one or two multiple-choice questions. Dialogues/monologues, questions, and answer choices are spoken. Questions are also printed in the test booklet.

Type Two: Contains longer dialogues and monologues with several multiple-choice questions. Dialogues/monologues and questions are only spoken and not printed in the test booklet. Answer choices are not spoken; they appear only in the test booklet.

Recommended Preparation

Both tests reflect general trends in high school curricula and are independent of particular textbooks or methods of instruction. Recommended preparation includes:

- Two to four years of study in high school or the equivalent
- Gradual development of competence in German over a period of years
- If you are taking the German with Listening Test, review sample listening questions using an SAT Subject Test Practice CD that your counselor can order from the College Board

| FORMAT/CONTENT — GERMAN | Approximate % of Test |
|--|--------------------------|
| 85 multiple-choice questions | |
| Skills Measured | |
| Vocabulary in context and Structure in context (grammar) | 50% |
| Reading comprehension Authentic stimulus materials and passages | 50% |

| FORMAT/CONTENT — GERMAN with LISTENING | Approximate % of Test |
|--|--------------------------|
| Approximately 85 multiple-choice listening and reading questions | |
| Listening Section (20 minutes) | 35% |
| Short dialogues/monologues Long dialogues/monologues | |
| Reading Section (40 minutes) | 65% |
| Vocabulary in context Structure in context (grammar) Reading comprehension using authentic stimulus materials and passages | |

Sample Reading Questions

Several types of questions are used in the Subject Test in German. All questions in the test are multiple-choice questions in which you must choose the BEST response from the four choices offered.

Part A

Directions

This part consists of a number of incomplete statements, each having four suggested completions. Select the most appropriate completion and fill in the corresponding circle on the answer sheet.

1. Der Präsident hat gestern Abend eine ----- gehalten.
(A) Rede
(B) Sprache
(C) Nachricht
(D) Erklärung
2. Der nächste Bus ----- um zehn Uhr ab.
(A) fährt
(B) fahr
(C) fahre
(D) fährt
3. Wissen Sie, ----- dieser Hund gehört?
(A) wer
(B) wo
(C) wessen
(D) wem
4. Ich glaube bestimmt, dass ----- .
(A) Thorsten heute pünktlich kommt
(B) Thorsten kommt heute pünktlich
(C) kommt Thorsten heute pünktlich
(D) heute kommt Thorsten pünktlich

Part B

Directions

In the following paragraph, there are numbered blanks indicating that words or phrases have been omitted. For each numbered blank, four completions are provided. First read through the entire paragraph. Then, for each numbered blank, choose the completion that is most appropriate and fill in the corresponding circle on the answer sheet.

Verspätung

Solange ich ihn (5), ist er immer pünktlich (6); ich

5. (A) weiß (B) kenne (C) verstehe (D) kann
6. (A) gewesen (B) worden (C) geworden (D) gewusst

verstehe (7) nicht, warum er uns

7. (A) damit (B) dadurch (C) darin (D) deshalb

diesmal im (8) gelassen hat.

8. (A) Loch (B) Vergessen (C) Stich (D) Mangel

Part C

Directions

Read the following texts carefully for comprehension. Each is followed by a number of questions or incomplete statements. Select the answer or completion that is best according to the text and fill in the corresponding circle on the answer sheet.

Question 9

Weltstadt-Wochenende zu zweit zu gewinnen!

- An einem Freitag anreisen und bis Sonntag bleiben
- Im erstklassigen Hotel verwöhnt werden
- Weltstadt-Programm erleben
- Das alles auf unsere Kosten

Name:
Straße:
Ort:

Viel Glück!

9. Was könnte man mit diesem Schein gewinnen?

- (A) Ein bezahltes Wochenende
(B) Einen Urlaub am Meer
(C) Ein tolles Auto
(D) Ein super Hotel

Questions 10-11

Hotel Edelweiß-MÜNCHEN

320 Betten zu vernünftigen Preisen
Internetanschluss für geringe Gebühr, Kabelfernsehen
bekanntes Stadrestaurant „Zirbelstube“
Konferenzräume für 10-250 Personen, Tagesbar
Gegenüber Hauptbahnhof, Bahnstraße 326,
Telefon (555) 55115-0

10. Für wen liegt dieses Hotel besonders günstig?

- (A) Für Bootsfahrer
(B) Für Flugzeugpassagiere
(C) Für Motorradfahrer
(D) Für Zugreisende

11. Was kann man in diesem Hotel machen?

- (A) Große Veranstaltungen halten
(B) Ins Fitnessstudio gehen
(C) Kostenlos Internet nutzen
(D) Ins Schwimmbad gehen

Questions 12-14

Die Frage, ob Bewegung wirklich der Gesundheit dient, beschäftigt nach wie vor sowohl die Mediziner als auch alle diejenigen, die mit Judging, Chairman und Schwitzen ihr Herzinfarkttrisiko zu verkleinern hoffen.

Bevölkerungsstudien geben viele Beweise dafür, dass Herztraining—bestimmte körperliche Übungen mindestens dreimal in der Woche, die für mindestens 30 Minuten den Puls beschleunigen—tatsächlich die Gefahr von Herzkrankheiten reduzieren kann. Laboruntersuchungen hingegen waren bisher nicht ganz klar. Großes Interesse fand jedoch eine Studie der Universitätsklinik Boston. Nach regelmäßigem Training in einem Laufrad überstand eine Versuchsgruppe von Affen die Folgen einer schlechten Ernährung besser als eine Vergleichsgruppe. Diese Gruppe hatte bei gleicher Ernährung keine Bewegung. Natürlich muss das Experiment wiederholt und verbessert werden. Immerhin ist dies das erste Versuchsergebnis mit höheren Primaten, z.B. Affen, das zeigt, dass man durch körperliche Bewegung Herzerkrankungen verhindern kann.

12. Es gibt viele Beweise dafür, dass Herzinfarkte bei Menschen nicht so häufig auftreten, wenn sie
- (A) zu viel essen
 - (B) fit bleiben
 - (C) Bewegung vermeiden
 - (D) Tierversuche machen

13. Der Verfasser des Berichtes macht es klar, dass
- (A) die Vergleichsgruppe kein Verhältnis zur Versuchsgruppe hat
 - (B) Bewegung der menschlichen Gesundheit nur schaden kann
 - (C) das Experiment wiederholt werden muss
 - (D) der Puls nie beschleunigt werden kann

14. In diesem Artikel geht es in erster Linie um eine Frage
- (A) des Sporttraining
 - (B) der Ernährung
 - (C) der Labormethoden
 - (D) der Gesundheit

Sample Listening Questions

On the German with Listening Test, the following two types of listening questions will appear in addition to the reading questions discussed previously. In the actual test, the listening section will come first. All questions in this part of the test are multiple-choice questions in which you must choose the BEST response from the four choices offered.

Text in brackets [] is only spoken and not printed in your test booklet.

Part A

Directions

In this part of the test you will hear several selections. They will not be printed in your test booklet. You will hear them only once. Therefore, you must listen very carefully. In your test booklet you will read one or two short questions about what was said. Another speaker will read the questions for you. Each question will be followed by four choices marked (A), (B), (C), and (D). The choices are not printed in your test booklet. You will hear them once. Select the best answer and fill in the corresponding circle on your answer sheet.

- (Narrator) [Question 15 refers to the following exchange.]
- (Man B) [Hmmm, das riecht gut. Was gibt's denn heute Abend zu essen?]
- (Man A) Für dich nichts, Klaus, weil du immer so spät nach Hause kommst.
- (Man B) Entschuldige, Rainer. Aber das war nicht meine Schuld—heute. Die Chefin gab mir in der letzten Minute noch viel zu tun.]

15. (Narrator) [Number 15.] Was gefällt Rainer nicht?
 (Woman) [Was gefällt Rainer nicht?]
 (Man) [(A) Klaus kommt spät.
 (B) Die Chefin arbeitet viel.
 (C) Klaus hat gegessen.
 (D) Es riecht so gut.]
- (5 seconds)

- (Narrator) [Questions 16 and 17 refer to the following exchange.]
- (Man A) [Herr Lenz, es ist schon 6.00 Uhr, und Sie sitzen immer noch am Schreibtisch!]
- (Man B) Ich fahre doch morgen in Urlaub und wollte keine Arbeit liegen lassen.
- (Man A) Lassen Sie mal. Am Montag bekomme ich eine Hilfskraft. Gehen Sie nach Hause und packen Sie.]

16. (Narrator) [Number 16.] Warum sitzt Herr Lenz noch am Schreibtisch?
 (Woman) [Warum sitzt Herr Lenz noch am Schreibtisch?]
 (Man) [(A) Er telefoniert.
 (B) Er packt ein.
 (C) Er arbeitet.
 (D) Er fährt heim.]
- (5 seconds)

17. (Narrator) [Number 17.] Wo unterhalten sich die Männer?
 (Woman) [Wo unterhalten sich die Männer?]
 (Man) [(A) Im Urlaub
 (B) Im Zug
 (C) Zu Hause
 (D) Im Büro]
- (5 seconds)

Part B

Directions

You will now listen to some extended dialogues or monologues. You will hear each only once. After each dialogue or monologue, you will be asked several questions about what you have just heard. These questions are not printed in your test booklet. From the four printed choices, select the best answer to each question and fill in the corresponding circle on the answer sheet. There is no sample question for this part.

Questions 18-21

(Narrator) [You will hear a telephone conversation about a car deal.]

(Telephone rings)

(Woman) [Hallo—Müller hier.]

(Man) Ich habe in der „Morgenpost“ gelesen, dass Sie ein Auto zu verkaufen haben. Können Sie mir etwas über den Wagen sagen?

(Woman) Ja, der Wagen ist drei Jahre alt, hat ungefähr 45 000 km und ein Schiebedach. Er ist in gutem Zustand. Er steht immer nachts in der Garage, und ich hatte noch nie einen Unfall damit.

(Man) Wann war der Wagen das letzte Mal zur Inspektion beim TÜV?

(Woman) Ende letzten Jahres.

(Man) Gibt es irgendwelche Probleme mit dem Wagen?

(Woman) Vor einigen Monaten ließ sich die Tür auf der Fahrerseite nicht schließen. Wir haben sie aber reparieren lassen.

(Man) Ich habe gegen 17.00 Uhr Feierabend, kann ich dann vorbeikommen?

(Woman) Ja, ich wohne Holunderweg 7.

(Man) Ach, da sind wir ja beinahe Nachbarn. Ich werde kurz nach 18.00 Uhr bei Ihnen sein.

(Woman) Gut dann: Auf Wiedersehen.]

18. (Narrator) [Number 18.] [Woher weiß der Mann, dass die Frau ein Auto zu verkaufen hat?]

(12 seconds)

- (A) Er hat es in der Zeitung gelesen.
- (B) Sie hat einen Brief an ihn geschrieben.
- (C) Seine Autowerkstatt hat es ihm gesagt.
- (D) Die Nachbarn haben es ihm erzählt.

19. (Narrator) [Number 19.] [Warum war das Auto in der Werkstatt?]

(12 seconds)

- (A) Weil es in einen Unfall verwickelt war.
- (B) Weil die Karosserie verkratzt war.
- (C) Weil die Tür auf der Fahrerseite nicht zugging.
- (D) Weil man die Fenster nicht schließen konnte.

20. (Narrator) [Number 20.] [Wann wird sich der Mann den Wagen ansehen?]

(12 seconds)

- (A) Kurz vor Feierabend
- (B) Nach der Arbeit
- (C) Am Morgen
- (D) Am Wochenende

21. (Narrator) [Number 21.] [Warum ist das Auto so gut wie neu?]

(12 seconds)

- (A) Weil es gerade aus der Werkstatt kam.
- (B) Weil es zur Inspektion muss.
- (C) Weil es nachts nicht auf der Straße steht.
- (D) Weil es über 45 000 km drauf hat.

ANSWERS

The estimated difficulty level, on a scale of 1 to 5, with 1 the easiest and 5 the most difficult, is in parentheses.

Reading Questions

- | | | | |
|----------|----------|-----------|-----------|
| 1. A (4) | 5. B (2) | 9. A (1) | 13. C (3) |
| 2. D (2) | 6. A (2) | 10. D (3) | 14. D (3) |
| 3. D (4) | 7. D (3) | 11. A (3) | |
| 4. A (4) | 8. C (5) | 12. B (1) | |

Listening Questions

- | | | | |
|-----------|-----------|-----------|-----------|
| 15. A (2) | 17. D (1) | 19. C (3) | 21. C (3) |
| 16. C (1) | 18. A (3) | 20. B (4) | |

Answer explanations for these practice questions are available online. Visit sat.collegeboard.org/practice/german to view and download the complete document.

Modern Hebrew

Questions cover topics emphasized in most high school courses. Because of course differences, most students will find that there are some questions on topics with which they are not familiar. You may not be able to complete all the questions in the time given, but it is not necessary to get every question correct to get a high score or even the highest score on the test.

Skills Covered in the Context of Modern Hebrew

Vocabulary: These types of questions test knowledge of words representing different parts of speech and some basic idioms within culturally authentic contexts.

Structure: This kind of question tests grammar, including parts of speech as well as your ability to recognize appropriate language patterns.

Reading Comprehension: Reading comprehension questions test your understanding of passages of varying levels of difficulty. These passages are generally adapted from literary sources and newspaper or magazine articles. Authentic material, such as advertisements, has been added to the test. While some passages have biblical references, no material in the test is written in biblical Hebrew.

Recommended Preparation

The Modern Hebrew Test allows for variation in language preparation. It is independent of particular textbooks or methods of instruction. Recommended preparation includes:

- Two to four years of Hebrew language study in high school or the equivalent
- Gradual development of competence in Hebrew over a period of years

| FORMAT/CONTENT | Approximate % of Test |
|--------------------------------|-----------------------|
| 85 multiple-choice questions | |
| Skills Measured | |
| Vocabulary in context | 30% |
| Structure in context (grammar) | 30% |
| Reading comprehension | 40% |

Sample Questions

Three types of questions are used in the Modern Hebrew Subject Test. All questions in the test are multiple choice and require you to choose the BEST response from the four choices offered.

Part A

Directions

This part consists of a number of incomplete statements, each having four suggested completions. Select the most appropriate completion and fill in the corresponding circle on the answer sheet.

1. אני _____, אבל אינני יכול ללכת

אתה לקונצרט הערב.

(A) משתלם (B) מתפאר

(C) מצטער (D) מתקרר

2. בגלל הגשמים לא היתה _____

לטייל ברגל.

(A) מטריה (B) סערה

(C) זהירות (D) אפשרות

3. אתמול שוחחתי בטלפון עם חברתי

מישראל ושמעתי _____ מצוין.

(A) אותה (B) אתה

(C) אליה (D) אותך

4. בקשנו מבעל-הבית _____ את

המנעול שהתקלקל.

(A) לתקן (B) לבלות

(C) להסגיר (D) לבנות

5. הרוח החזקה גרמה _____ רב

לרכוש התושבים.

(A) מזיק (B) נזק

(C) ברק (D) רעם

11. (A) מאוחרות (B) אחרות
(C) אחידות (D) אקדוח

12. (A) רואים (B) אוהבים
(C) מקנים (D) גאים

Part C

Directions

Read the following passages carefully for comprehension. Each is followed by a number of questions or incomplete statements. Select the answer or completion that is best according to the passage and fill in the corresponding circle on the answer sheet.

דרושים מורים למתמטיקה ולמדע לכיתות ה-ו,
לחצי משרה או למשרה מלאה.
דרישות: תואר ראשון בתחום מתאים,
ותעודת הוראה.
בית ספר תומר, רח' בן יהודה.
טלפון: 556677.



13. הפרסומת מודיעה על
(A) מורים שמחפשים עבודה
(B) מקומות עבודה למורים
(C) ספרי למוד למתמטיקה ומדע
(D) תעודות למורים

14. לפי הפרסומת דרושים
(A) מורים בארצות-הברית
(B) כתות גדולות
(C) ספרי למוד
(D) בעלי תואר ראשון

15. 556677 הוא מספר הטלפון של
(A) המורה
(B) בית ספר תומר
(C) בן יהודה
(D) הכתה

6. כל ארבע שנים מתקיימות _____
לנשיאות ארצות-הברית.
(A) הבטחות (B) התחרויות
(C) ממשלות (D) בחירות

Part B

Directions

In each of the following paragraphs there are numbered blanks indicating that words or phrases have been omitted. For each numbered blank, four completions are provided. First read through the entire paragraph. Then, for each numbered blank, choose the completion that is most appropriate and fill in the corresponding circle on the answer sheet.

חנה למדה רפואה. היא למדה הרבה שנים
(7) _____ להיות רופאה בחדר ניתוח והיא
מקנה שבשנה הבאה היא תקבל תעודת רפואה.
הוריה עזרו (8) _____ להגשים את (9) _____
עקשו היא רוצה לעבד בבית-חולים בעיר בה
גדלה ולהחזיר להוריה לפחות (10) _____
מן הכסף ששלמו עבור למדינה. משפחתה
של חנה עלתה מאיראן לפני שנים (11) _____
והיא הראשונה במשפחה שתהיה רופאה.
כלם (12) _____ בה מאד.

7. (A) כרי (B) אכל
(C) אם (D) כדאי
8. (A) אותה (B) לה
(C) אתה (D) אצלה

9. (A) רפואה (B) תקנה
(C) חלומה (D) בקשתה

10. (A) חלק (B) חלקה
(C) חלוקה (D) חלוק

נשים סופרות בישראל

17. מה היתה הטענה נגד כלי התקשורת?

- (A) שאין די הערכה לנשים סופרות
- (B) שהם שבחו רק גברים סופרים
- (C) שהם מעסיקים רק גברים
- (D) שלא שדרו פתבות על נשים סופרות

18. למה הסופרת התרגזה?

- (A) כי רצו להראות אותה מכינה אכל
- (B) כי היא עבדה קשה במטבח
- (C) כי בקשו ממנה לעבד בטלויזיה
- (D) כי היא אינה אוהבת להצטלם

19. בין המשתתפים בדיון

- (A) לא היו צלמי טלויזיה
- (B) היו דעות מנוגדות
- (C) היו אנשים חשוכים
- (D) לא היו סופרות

20. רב הסופרות חשבו

- (A) שבדיונים צריך להפריד בין סופרות לסופרים
- (B) שלא חשוב מי הכותב - גבר או אשה
- (C) שהטלויזיה צריכה להקדיש זמן ליצירות של נשים
- (D) שחשוב להדגיש שאשה כתבה את היצירה

בישראל התקיים דיון על הנושא: כיצד

מתייחסים בעתונות, ברדיו ובטלויזיה לנשים סופרות. היו שטענו שהם אינם נותנים לאשה הסופרת אותו כבוד שנותנים לסופר. בין המשתתפים בדיון היו גם כמה מן הסופרות עצמן. אחת מהן ספרה שכאשר ראינו אותה עבור הטלויזיה בקשו לצלם אותה במטבח כשהיא מבשלת. היא כעסה ואמרה שמה שהיא עושה במטבח אינו אומר דבר על עבודתה כסופרת.

שאלה נוספת היתה אם יש הבדל בין ספרות הנכתבת על ידי נשים לבין זאת הנכתבת על ידי גברים. בנושא זה היו חלוקי דעות קשים בין המשתתפים. כמעט כל הסופרות טענו שהן אינן רוצות שידגישו את העובדה שהן נשים. הן חושבות שצריך לדון ביצירה ספרותית לעצמה. לבדק אותה באותם כלים שבהם בודקים כל יצירה ספרותית מבלי להתחשב אם היצירה נכתבה על ידי סופר או סופרת.

16. במה דן הקטע?

- (A) בקשר בין סופרים ועתונאים
- (B) במעמד של נשים סופרות בתקשורת
- (C) בבציות צלום לטלויזיה
- (D) במטבח הישראלי

ANSWERS

The estimated difficulty level, on a scale of 1 to 5, with 1 the easiest and 5 the most difficult, is in parentheses.

- | | | | |
|----------|-----------|-----------|-----------|
| 1. C (1) | 6. D (5) | 11. D (5) | 16. B (2) |
| 2. D (2) | 7. A (1) | 12. D (4) | 17. A (5) |
| 3. A (3) | 8. B (2) | 13. B (4) | 18. A (4) |
| 4. A (4) | 9. C (3) | 14. D (3) | 19. B (4) |
| 5. B (5) | 10. A (2) | 15. B (1) | 20. B (3) |

Answer explanations for these practice questions are available online. Visit sat.collegeboard.org/practice/hebrew to view and download the complete document.

Italian

Questions cover topics emphasized in most high school courses. Because of course differences, most students will find that there are some questions on topics with which they are not familiar. You may not be able to complete all the questions in the time given, but it is not necessary to get every question correct to get a high score or even the highest score on the test.

Skills Covered in the Context of the Italian Language

Passage Completion: These questions test your knowledge of commonly used vocabulary, appropriate idiomatic expressions, and language structure in the context of paragraphs.

Sentence Completion: These questions test your familiarity with grammatical structure and vocabulary.

Reading Comprehension: Reading comprehension questions test your understanding of the content of various selections taken from sources such as newspaper and magazine articles, fiction, historical works, advertisements, tickets, brochures, forms, and schedules. Commonly taught grammatical constructions are tested, and all questions reflect current standard Italian.

The test questions range in difficulty from elementary through advanced, although most questions are at the intermediate level.

Recommended Preparation

The Subject Test in Italian allows for variation in language preparation. It is independent of particular textbooks or methods of instruction. Recommended preparation includes:

- Two to four years of Italian language study in high school or the equivalent
- Gradual development of competence in Italian over a period of years

| FORMAT/CONTENT | Approximate % of Test |
|---------------------------------|-----------------------|
| 80–85 multiple-choice questions | |
| Skills Measured | |
| Vocabulary | 30% |
| Structure | 30% |
| Reading comprehension | 40% |

Sample Questions

Three types of questions are used in the Italian Subject Test. All questions in the test are multiple-choice questions in which you must choose the BEST response from the four choices offered.

Part A

Directions

In the following passage there are numbered blanks indicating that words or phrases have been omitted. For each numbered blank, four completions are provided. First read through the entire passage. Then, for each numbered blank, choose the completion that is most structurally and logically appropriate, given the context of the entire passage, and fill in the corresponding circle on the answer sheet.

Un paio di blue-jeans

Ho portato blue-jeans sin da quando se ne portavano pochissimi e comunque solo in vacanza. Li trovavo e li trovo molto (1) specie in viaggio perchè non ci sono problemi di piega. Oggi si portano anche per bellezza, ma sono prima di tutto molto (2). Solo che da parecchi anni avevo dovuto (3) a questo piacere, perchè ero ingrassato.

Recentemente, ho perso quel numero di (4) sufficiente per riprovare un blue-jeans quasi normale. Ho provato una dozzina di blue-jeans ed ogni (5) la commessa del negozio mi diceva: “Stringa, vedrà che poi si (6).” Finalmente ne ho trovato uno e sono partito, senza dover tirare indietro la pancia.

1. (A) colorati (B) costosi
(C) comodi (D) stretti
2. (A) utili (B) difficili
(C) vecchi (D) strani
3. (A) rinunciare (B) rassegnarmi
(C) consentire (D) attenermi
4. (A) metri (B) litri
(C) chili (D) chilometri
5. (A) cosa (B) volta
(C) modo (D) giorno
6. (A) ritirano (B) lavano
(C) formano (D) adattano

Part B

Directions

Directions: In each sentence or dialogue below you will find a blank space indicating that a word or phrase has been omitted. Following each sentence are four completions. Of the four choices, select the one that best completes the sentence structurally and logically and fill in the corresponding circle on the answer sheet. In some instances, choice (A) may consist of dashes; by choosing this option, you are indicating that no insertion is required to form a grammatically correct sentence.

7. Che ----- sconti!
(A) belli (B) begli
(C) belle (D) bei
8. Ti piacciono queste camicie? ----- ho comprate per Gianna.
(A) Le (B) La
(C) Gli (D) Li

Part C

Directions

Read the following texts carefully for comprehension. Each text is followed by a number of questions or incomplete statements. Select the answer or completion that is best according to the text and fill in the corresponding circle on the answer sheet.

Questions 9-10

Cebion® è vitamina C.
Cebion ti aiuta.
È un medicinale, usare con cautela.
Leggere attentamente le avvertenze—Aut. min. San. n. 7440—Codice n. 003366034

9. Cebion è
(A) un codice (B) una medicina
(C) un'avvertenza (D) un cibo
10. Questo prodotto si deve usare
(A) ogni giorno (B) con la vitamina C
(C) prima dei pasti (D) con cura

Questions 11-14

Cari lettori,

Gli scioperi dei treni hanno causato in questi giorni non pochi problemi. Ogni mattina mi sono alzato tendendo l'orecchio ai giornali radio, pronto ad adeguarmi ad ogni nuova circostanza, a muovermi in macchina (nebbia permettendo) o in aereo (scioperi,

anche qui, permettendo). Ma non voglio lamentarmi degli scioperi. Anch'io sono un lavoratore dipendente e so che è giusto farli, quando occorrono, salvo tutelare i diritti degli utenti. Quanto ai treni (ahimè!) lo sciopero non mi ha sconvolto più di tanto. So di non poter contare sulle nostre ferrovie al cento per cento, so che i ritardi, soprattutto su certe linee, sono piuttosto frequenti. Parlo per esperienza. Io ho molti parenti in Emilia e spesso ricevo le loro visite. Una volta andavo alla Stazione Centrale ad aspettarli. Ora, da almeno dieci anni, non lo faccio più, per non passare ore a vuoto in attesa di treni che non sono mai puntuali. Pazienza! Bisogna accettare ciò che passa il convento e rassegnarsi. Riuscirà la nuova linea che accorcerà le distanze tra Milano e Roma a risolvere la situazione? Me lo auguro.

E.F.

11. Chi scrive questa lettera?
(A) Il padrone di una ditta
(B) Un controllore
(C) Un impiegato
(D) Un disoccupato
12. Cosa pensa degli scioperi l'autore della lettera?
(A) Che sono illegali
(B) Che sono qualche volta giustificati
(C) Che dovrebbero essere aboliti
(D) Che sono sempre utili
13. L'autore considera lo sciopero dei treni con
(A) allegria (B) incomprensione
(C) rabbia (D) rassegnazione
14. Dieci anni fa, E.F. ha deciso di
(A) non aspettare più alla stazione
(B) lamentarsi degli scioperi
(C) non dare appoggio ai lavoratori
(D) non ascoltare la radio la mattina

ANSWERS

The estimated difficulty level, on a scale of 1 to 5, with 1 the easiest and 5 the most difficult, is in parentheses.

- | | | | |
|----------|----------|-----------|-----------|
| 1. C (2) | 5. B (3) | 9. B (1) | 13. D (2) |
| 2. A (3) | 6. D (4) | 10. D (2) | 14. A (1) |
| 3. A (4) | 7. B (2) | 11. C (2) | |
| 4. C (5) | 8. A (2) | 12. B (4) | |

Answer explanations for these practice questions are available online. Visit sat.collegeboard.org/practice/italian to view and download the complete document.

Japanese with Listening

Questions cover topics emphasized in most high school courses. Because of course differences, most students will find that there are some questions on topics with which they are not familiar. You may not be able to complete all the questions in the time given, but it is not necessary to get every question correct to get a high score or even the highest score on the test.

Remember to bring an acceptable CD player and fresh batteries with you on test day. See page 3 for more information.

Skills Covered in the Context of the Japanese Language

Listening Comprehension: These questions are based on short spoken dialogues and narratives, primarily about everyday topics. A brief explanation about each selection and the questions are given in English. Explanations are also printed in the test booklet.

Usage: These questions require you to complete Japanese sentences in a way that is appropriate in terms of structure (grammar), vocabulary, and context.

Usage questions are printed in two different ways of representing Japanese. In the left column, the Japanese is written in the most common type of Romanization (romaji), a modified Hepburn system. In the right column, the Japanese is presented in standard Japanese script with furigana for all kanji. You should choose the writing system you are familiar with and read only from that column on the test.

Reading Comprehension: The reading comprehension questions are in English and test your understanding of such points as main and supporting ideas. The selections in this section are taken from materials you might encounter in everyday situations, such as notes, menus, newspaper articles, advertisements, and letters. The text is written in *hiragana*, *katakana* and *kanji* without *furigana*.

Recommended Preparation

- Study of Japanese for two to four years in high school or the equivalent
- Gradual development of competence in Japanese over a period of years
- Review sample listening questions using an SAT Subject Test Practice CD that your counselor can order from the College Board

| FORMAT/CONTENT | Approximate % of Test |
|---------------------------------------|-----------------------|
| 80 multiple-choice questions | |
| Skills Measured | |
| Listening Section (20 minutes) | |
| Listening comprehension | 33% |
| Reading Section (40 minutes) | |
| Usage | 33% |
| Reading comprehension | 33% |

Sample Listening Questions

All questions in the test are multiple choice. You must choose the BEST response from the four choices offered.

Directions

(Narrator) [This is a sample audio CD for the Japanese Test with Listening.]

Directions: In this section of the test you will hear short dialogues and monologues. You will hear them only once and they are not printed in your test booklet. At the end of each selection, you will be asked questions about what was said. Now listen to the following example, but do not mark the answer on your answer sheet.]

Question 1

(Narrator) [Listen to this short exchange in a stationery store.]

(Woman) 「これ3冊下さい。」

(Man) 「3冊ですね? はい、1200円です。」

(Narrator) [What did the woman buy?]

(16 seconds)

1. (A) Pens
(B) Notebooks
(C) Erasers
(D) Colored paper

Question 2

(Narrator) [Listen to this short conversation between two acquaintances.]

(Man) 「今日も車で来ましたか。」

(Woman) 「いいえ、いつも車で来るんですけど、今日はバスできました。」

(Narrator) [Question 2. How did the woman get there today?]

(16 seconds)

2. (A) By bus
(B) By car
(C) By train
(D) On foot

Question 3

(Narrator) [Now listen to the message on Mr. Nakamura's answering machine in his office.]

(Man) 「あ、もしもし中村さん。こちらはABCテレビの川上です。今晚会社の方にお電話下さいませんか。では、よろしくお願いたします。」

(Narrator) [Question 3. When is Mr. Nakamura expected to call?]

(16 seconds)

3. (A) This morning
(B) Tonight
(C) Tomorrow morning
(D) Tomorrow night

Question 4

(Narrator) [Listen to this conversation at the woman's home. Then answer question 4.]

(Woman) 「もう一杯いかがですか。」

(Man) 「いえ、結構です。」

(Woman) 「まあ、そうおっしゃらないで、小さいコップですから。」

(Man) 「そうですか。じゃあ、少し頂きます。」

(Narrator) [Question 4. What most likely is the man's relationship to the woman?]

(16 seconds)

4. (A) He is her guest.
(B) He is her husband.
(C) He is her son.
(D) He is her close friend.

Sample Usage Questions

Directions

This section consists of a number of incomplete statements, each of which has four suggested completions. In some instances, choice (A) may consist of dashes that indicate that no insertion is required to form a correct sentence. Select the word or phrase that best completes the sentence structurally and logically and fill in the corresponding circle on the answer sheet.

This section of the test is presented in two columns that provide identical information. Look at the example below and choose the one column of writing with which you are most familiar in order to answer the question. Do not waste time by switching from one column to the other in this section.

5. ----- narimashita.

- (A) kirei
(B) osoku
(C) genki na
(D) benri

5. ----- になりました。

- (A) きれい
(B) ^{おそ}遅く
(C) ^{げんき}元気な
(D) ^{べんり}便利

6. Hima ----- toki, jingingu o shimasu.

- (A) -----
(B) na
(C) no
(D) ni

6. ひま ----- ^{とき}時、ジョギングをします。

- (A) -----
(B) な
(C) の
(D) に

Sample Reading Questions

Directions

Read the following texts carefully for comprehension. Each text is followed by one or more questions or incomplete statements based on its content. Select the answer or completion that is best according to the text and fill in the corresponding circle on the answer sheet. There is no example for this section.

Questions 7-8

This is a notice on a bulletin board.

ネコを探しています。

毛の長い白ネコ
体長約四十センチ
首に茶色のリボン

こんなネコを見た方は、
木村（電話三八五〇三九九四）
までご連絡ください。

7. The writer wants to
- (A) find a lost cat
 - (B) give away a cat
 - (C) find the owner of a cat
 - (D) sell a cat
8. The description says the cat is
- (A) brown
 - (B) green-eyed
 - (C) long-haired
 - (D) young

Question 9

Ryan's host mother left a note for him.

ライアンくん、
明日、朝早いから先に寝ます。晩ごはんは電子レンジで
温めてください。明日のハイキングですが、7時半までに
起きてください。ジーンズは洗っておきました。

9. What is Ryan to do by seven thirty?
- (A) Get up
 - (B) Eat
 - (C) Go out
 - (D) Go to bed

ANSWERS

The estimated difficulty level, on a scale of 1 to 5, with 1 the easiest and 5 the most difficult, is in parentheses.

1. B (1) 3. B (1) 5. B (3) 7. A (4) 9. A (3)
2. A (2) 4. A (3) 6. B (2) 8. C (3)

Answer explanations for these practice questions are available online. Visit sat.collegeboard.org/practice/japanese to view and download the complete document.

Korean with Listening

Questions cover topics emphasized in most high school courses. Because of course differences, most students will find that there are some questions on topics with which they are not familiar. You may not be able to complete all the questions in the time given, but it is not necessary to get every question correct to get a high score or even the highest score on the test.

Remember to bring an acceptable CD player and fresh batteries with you on test day. See page 3 for more information.

Skills Covered in the Context of the Korean Language

Listening Comprehension: These questions test your ability to understand the spoken language. They are based on short, spoken Korean dialogues and narratives, primarily about everyday topics. All listening questions and answer options are in English. The questions will be spoken on a CD. They will also be printed in the test booklet.

Usage: These questions are written entirely in *Han'gŭl* and require students to complete Korean sentences or phrases so that they are structurally and logically correct. Areas covered include vocabulary, honorifics, and various aspects of grammatical structure.

Reading Comprehension: The reading comprehension questions test your understanding of such points as main and supporting ideas. All passages in this section are written in *Han'gŭl* and all questions are in English. Most questions deal with understanding literal meaning, although some inference questions may be included. The Korean selections are drawn from authentic materials, such as notes, diaries, newspaper articles, advertisements, letters, and literary texts.

Recommended Preparation

- Two to four years of Korean language study in high school or the equivalent
- Gradual development of competence in Korean over a period of years
- Review sample listening questions using an SAT Subject Test Practice CD that your counselor can order from the College Board

| FORMAT/CONTENT | Approximate % of Test |
|---------------------------------------|-----------------------|
| 80 multiple-choice questions | |
| Skills Measured | |
| Listening Section (20 minutes) | |
| Listening comprehension | 33% |
| Reading Section (40 minutes) | |
| Usage | 33% |
| Reading comprehension | 33% |

Sample Listening Questions

Directions

(Narrator) [This is a sample audio CD for the Korean test with Listening.]

Directions: In this part of the test you will hear several spoken selections. They will not be printed in your test booklet. You will hear them **only once**. After each selection you will be asked one or more questions about what you have just heard. These questions, with four possible answers, are printed in your test booklet. Select the best answer to each question from among the four choices printed and fill in the corresponding circle on your answer sheet. Now listen to the first selection.]

(Narrator) [Listen to the following conversation. Then answer questions 1 and 2.]

(Woman) [한수야, 어제 전화했는데, 너 어디 갔었니?

(Man) 어제 우리형이 동부에서 와서 공항에 마중 나갔었어.

(Woman) 너, 형이 동부에 살아?

(Man) 응, 대학교도 거기서 다녔는데, 지금은 졸업하고 회사에 다녀.

(Woman) 좋겠다. 형이 와서.

여기 얼마나 있을 건데?

(Man) 오래 있으면 좋을 텐데, 휴가가 사흘밖에 없다.]

(Narrator) [Question 1. Where did Hansu go yesterday?] (16 seconds)

- (A) To his brother's office
(B) To his brother's house
(C) To the airport
(D) To a graduation ceremony

(Narrator) [Question 2. Choose the correct statement based on the conversation you have just heard.]

(16 seconds)

- (A) Hansu's brother is moving in with Hansu.
(B) Hansu's brother has a four-day vacation.
(C) Hansu's brother works on the West Coast.
(D) Hansu's brother went to college on the East Coast.

(Narrator) [Listen to the following announcement.
Then answer question 3.]

(Man) [안내 말씀을 드리겠습니다.
오늘 새로 개통된 지하철 5호선이
기계 고장으로 오후 2시부터
운행이 일시 중단되었습니다. 현재
고치고 있사오니 3시간 후면 다시
운행될 예정입니다. 5호선을
이용하실 분은 4호선을 이용해
주시기 바랍니다.
거듭 사과 말씀을 드립니다.]

(Narrator) [Question 3. What is being announced?]
(16 seconds)

- 3. (A) That service is not affected.
- (B) That service will be restored.
- (C) That a new line will open on the following day.
- (D) That there will be no service at 3 o'clock.

Sample Usage Questions

Part A

Directions

This section consists of a number of incomplete statements, each of which has four suggested completions. Select the word or words that best complete the sentence structurally and logically and fill in the corresponding circle on the answer sheet.

5. 현주: 어렸을 때 꿈이 뭐였어요?
민우: 저는 어렸을 때 경찰이
_____.

- (A) 되어 있었어요
- (B) 되어 버렸어요
- (C) 되고 싶었어요
- (D) 되고 말았어요

6. 우리 언니는 오늘
숙제를 _____ 가는 바람에
학교에 _____ 다시 집에
돌아왔어요.

- (A) 잊어버리고.....가다가
- (B) 잊어버리고.....가면서
- (C) 잃어버리고.....가는데
- (D) 잃어버리고.....가지만

7. 이 차는 너무 낡아서
_____ 소용이 없을 거예요.

- (A) 고쳐 보면
- (B) 고쳐 봐야
- (C) 고치므로
- (D) 고치고야

4. 철수: 할아버지 진지 드셨어요?
할아버지: 그래, _____.

- (A) 잡셨다
- (B) 먹었다
- (C) 드셨다
- (D) 하셨다

Part B

Directions

In each of the following paragraphs there are numbered blanks indicating that words or phrases have been omitted. For each numbered blank, four completions are provided. First read through the entire paragraph. Then, for each numbered blank, choose the completion that is most appropriate and fill in the corresponding circle on the answer sheet.

나는 어려서부터 성격이 급해 서두른다는 말을 많이 들었다. 이런 성격 때문에 어른들께 꾸중도 _____ 들었고, 늘 학교에 가지고 가야 할 것을 텀병대고 집에 두고 가거나, 어디 놀러 갈 때는 이삼일 전부터 준비해 놓으라고 야단법석을 _____ 어머니 속을 무척 _____ 드렸다. 그러나 이 급한 성격 덕분에 숙제만은 학교에서 오자마자 먼저 해 놓고 놀기 때문에 숙제로 걱정_____.

- | | |
|-----------|-----------|
| 8. (A) 자주 | 9. (A) 덜어 |
| (B) 마침 | (B) 들어 |
| (C) 드디어 | (C) 떨어 |
| (D) 좀처럼 | (D) 틀어 |
-
- | | |
|------------|-------------------|
| 10. (A) 쉬여 | 11. (A) 해 본 적이 있다 |
| (B) 쉬어 | (B) 해 본 적이 없다 |
| (C) 썩여 | (C) 하는 수가 있다 |
| (D) 썩게 | (D) 하는 수가 없다 |

Sample Reading Questions

Directions

Read the following selections carefully for comprehension. Each selection is followed by one or more questions or incomplete statements based on its content. Choose the answer or completion that is best according to the selection and fill in the corresponding circle on the answer sheet.

Questions 12-13

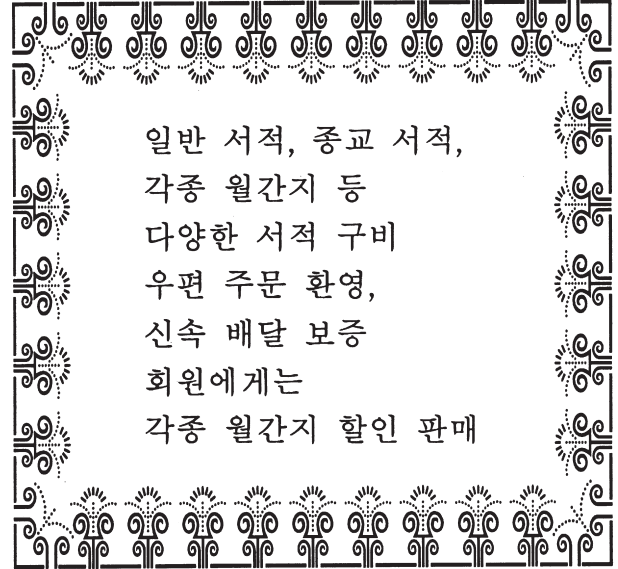

12. What kind of business is being advertised?
- (A) A bookstore
 (B) A gift shop
 (C) A delivery service
 (D) A drugstore
13. How can one receive a special discount?
- (A) By mail order
 (B) By using a credit card
 (C) By membership
 (D) By buying a large quantity

Questions 14-16

미국에 온 지 벌써 사 개월이 되었다. 여기 생활에 익숙해질 때까지 적어도 일 년쯤은 걸리지 않겠나 생각을 했는데, 미국 사람들이 몹시 친절하고 또 우리 학교 유학생 클럽에서 매주 한 번씩 미국 문화에 대한 세미나가 있기 때문에, 지금은 여기 생활에 조금도 불편을 느끼지 않을 정도가 되었다. 미국에는 여러 민족이 함께 살기 때문에, 다양한 문화를 이해하고 받아들이는 것도 대단히 중요하다. 미국에 오기 전에 사람들에게 영어를 꽤 편찮게 한다는 칭찬도 받아서 이 정도면 미국에 가서 큰 어려움은 없지 않을까 생각했는데, 잘못된 생각이었다. 역시 외국어는 그 나라 사람들과 직접 같이 생활하면서 늘 써 보기 전에는 자신을 가질 수가 없다는 것을 알게 되었다. 외국어를 배운다는 것은 그 나라 말만 배우는 것이 아니라 사고방식, 문화까지 다 포함한다는 것을 재삼 깨달았다.

14. How long did the writer think it would take to get used to American life?
- (A) About four months
 - (B) About four years
 - (C) At least a year
 - (D) A lifetime
15. What did the writer learn is important in American society?
- (A) To accept cultural diversity
 - (B) To speak many languages
 - (C) To help international students
 - (D) To befriend many people
16. What does the writer think is the best way to become proficient in English?
- (A) Memorizing a lot of vocabulary
 - (B) Attending various seminars
 - (C) Participating in student clubs
 - (D) Learning and thinking in English

ANSWERS

The estimated difficulty level, on a scale of 1 to 5, with 1 the easiest and 5 the most difficult, is in parentheses.

- | | | | |
|----------|----------|-----------|-----------|
| 1. C (2) | 5. C (3) | 9. C (3) | 13. C (3) |
| 2. D (3) | 6. A (4) | 10. C (4) | 14. C (3) |
| 3. B (4) | 7. B (3) | 11. B (3) | 15. A (4) |
| 4. B (2) | 8. A (3) | 12. A (2) | 16. D (4) |

Answer explanations for these practice questions are available online. Visit sat.collegeboard.org/practice/korean to view and download the complete document.

Latin

Questions cover topics emphasized in most high school courses. Because of course differences, most students will find that there are some questions on topics with which they are not familiar. You may not be able to complete all the questions in the time given, but it is not necessary to get every question correct to get a high score or even the highest score on the test.

Skills Covered in the Context of the Latin Language

- Select appropriate grammatical forms of Latin words
- Choose Latin words from which English words are derived
- Translate from Latin to English
- Complete Latin sentences
- Choose alternative ways of expressing the same thought in Latin
- Answer a variety of questions based on short passages of prose or poetry

The reading comprehension part has 30 to 37 questions based on three to five reading passages, at least one of which is a poetry passage. A set of questions following a poetry passage always includes one question requiring you to scan the first four feet of a line of dactylic hexameter verse or to determine the number of elisions in a line.

Recommended Preparation

- Two to four years of Latin study in high school (the equivalent of two to four semesters in college)
- Gradual development of competence in sight-reading Latin over a period of years

| FORMAT/CONTENT | Approximate % of Test |
|---------------------------------------|-----------------------|
| 70–75 multiple-choice questions | |
| Skills Measured | |
| Grammar and syntax | 30% |
| Derivatives | 5% |
| Translation and reading comprehension | 65% |

Sample Questions

Six types of questions are used in the Subject Test in Latin. All questions in the test are multiple-choice questions in which you must choose the BEST response from the four choices offered.

Note: In some questions, variations of Latin terms may appear in parentheses.

Directions

In each statement below, you are asked to give a specific form of the underlined word. Select the correct form from the choices given. Then fill in the corresponding circle on the answer sheet.

- The dative singular of senātus is
 (A) senātū (B) senātum
 (C) senātūs (D) senātuī
- The present subjunctive passive of capitis is
 (A) capīāminī (B) capīēminī
 (C) caperēminī (D) capiminī

Directions

Each of the following English sentences contains a word that is underlined. From among the choices, select the Latin word to which the underlined word is related by derivation. Then fill in the corresponding circle on the answer sheet.

- The transition from adolescence to adulthood was easy.
 (A) sedēre (B) īre
 (C) ferre (D) esse
- All things are possible.
 (A) pōnō (B) possum
 (C) possideō (D) poscō

Directions

In each of the sentences below, part or all of the sentence is underlined. From among the choices, select the best translation for the underlined word or words. Then fill in the corresponding circle on the answer sheet.

- Si vocāvissēs, laetī fuissēmus.
 (A) If you were calling
 (B) If you had called
 (C) If you are calling
 (D) If you should call
- Agricola dixit sē puellam visūrum esse.
 (A) that he would see the girl
 (B) that he had seen the girl
 (C) that the girl would see him
 (D) that they will see the girl
- Iter militibus faciendum est.
 (A) The journey was made by the soldiers.
 (B) The journey is being made by the soldiers.
 (C) The soldiers must make a journey.
 (D) The soldiers have made a journey.

Directions

Each of the sentences below contains a blank space indicating that a word or phrase has been omitted. For each blank, four completions are provided. Choose the word or phrase that best completes the sentence and fill in the corresponding circle on the answer sheet.

8. Servus ----- vulnerātur.
(A) ā saxō (B) saxum
(C) cum saxō (D) saxō
9. Vidistī ----- patriam incolunt.
(A) quōs (B) quī
(C) quem (D) cui

Directions

In each of the sentences below, part or all of the sentence is underlined. Select from the choices the expression that, when substituted for the underlined portion of the sentence, changes the meaning of the sentence LEAST. Then fill in the corresponding circle on the answer sheet.

10. Fortēs ā consule semper laudantur.
(A) Consul ā fortibus semper laudātur.
(B) Consul fortēs semper laudat.
(C) Fortēs consulem semper laudant.
(D) Consulēs fortēs semper laudantur.
11. Cīvēs vērunt ut pācem peterent.
(A) ad pācem petendam
(B) pāce petītā
(C) sī pax peterētur
(D) postquam pax petēbātur

Directions

Read the following text carefully for comprehension. It is followed by a number of questions or incomplete statements. Select the answer or completion that is best according to the text and fill in the corresponding circle on the answer sheet.

Honors for an emperor

Cum igitur in amōre omnium Marcus Antonīnus bene rēgnāvisset, octāvō decimō annō imperīi suī mortuus est. Priusquam fūnus celebrātum est, senātus populusque eum deum esse dixit. Mox
Line (5) nēmō erat quī eius imāginem in suā domō non habēret, hodiēque in multis domibus Marcī Antonīni statuae consistunt inter Penātēs. Neque dēfuērunt homines qui crēderent in somnīs eum multa quae vērā essent praedixisse.

12. In line 2, octāvō decimō annō is translated
(A) for eighteen years
(B) after eighteen years
(C) in the eighteenth year
(D) throughout the eighteenth year
13. The first two sentences (Cum . . . dixit) tell us that
(A) Antoninus arranged his own funeral before he died
(B) everyone celebrated Antoninus' funeral for eighteen days
(C) a god told the senate and people to celebrate Antoninus' funeral
(D) Antoninus was proclaimed a god by the senate and people
14. In line 5, suā refers to
(A) deum (line 4)
(B) nēmō (line 5)
(C) eius (line 5)
(D) imāginem (line 5)
15. The third sentence (Mox . . . Penātēs) tells us that
(A) Antoninus placed statues of the household gods in every home
(B) no one had a statue of Antoninus
(C) many statues of Antoninus replaced the household gods
(D) many houses had statues of Antoninus among the household gods
16. In line 9, praedixisse is translated
(A) would predict
(B) had predicted
(C) predicts
(D) will have predicted
17. The last sentence (Neque . . . praedixisse) tells us that
(A) people do not always believe their dreams
(B) Marcus Antoninus was believed to prophesy in dreams
(C) Marcus Antoninus believed in the truth of many dreams
(D) people predicted that many would believe their dreams

ANSWERS

The estimated difficulty level, on a scale of 1 to 5, with 1 the easiest and 5 the most difficult, is in parentheses.

- | | | | |
|----------|-----------|-----------|-----------|
| 1. D (3) | 6. A (4) | 11. A (3) | 16. B (3) |
| 2. A (4) | 7. C (4) | 12. C (3) | 17. B (4) |
| 3. B (3) | 8. D (3) | 13. D (3) | |
| 4. B (1) | 9. B (4) | 14. B (4) | |
| 5. B (3) | 10. B (4) | 15. D (3) | |

Answer explanations for these practice questions are available online. Visit sat.collegeboard.org/practice/latin to view and download the complete document.

Spanish and Spanish with Listening

Questions cover topics emphasized in most high school courses. Because of course differences, most students will find that there are some questions on topics with which they are not familiar. You may not be able to complete all the questions in the time given, but it is not necessary to get every question correct to get a high score or even the highest score on the test.

If you are taking the Spanish with Listening Test, remember to bring an acceptable CD player and fresh batteries with you on test day. See page 3 for more information.

Skills Covered in the Context of the Spanish Language

Reading questions implicitly test vocabulary throughout the test, but some questions specifically test word meaning in the context of a sentence that reflects spoken or written language. Understanding of various parts of speech (nouns, verbs, adjectives, adverbs, etc.) and idiomatic expressions is tested. The reading section also asks:

Vocabulary and Structure Questions: These questions ask you to identify usage that is both structurally correct and contextually appropriate. Other reading questions test vocabulary and grammatical usage in longer paragraphs.

Reading Questions: These questions are based on selections from prose fiction, historical works, and newspaper and magazine articles, as well as advertisements, flyers, and letters. They test points such as main and supporting ideas, themes, style, tone, and the spatial and temporal settings of a passage.

The listening section has three parts:

Part A questions ask you to identify the sentence that most accurately describes what is presented in a photograph or what someone in the photograph might say.

Part B questions test your ability to identify a plausible continuation of a short conversation.

Part C requires you to answer comprehension questions based on more extensive listening selections.

Recommended Preparation

Both tests reflect general trends in high school curricula and are independent of particular textbooks or methods of instruction. Recommended preparation includes:

- Three to four years of study in high school or the equivalent (Two years for advanced students)
- Gradual development of competence in Spanish over a period of years
- Review sample listening questions using an SAT Subject Test Practice CD that your counselor can order from the College Board, if you are taking the Spanish with Listening Test

FORMAT/CONTENT — SPANISH

Approximate
% of Test

85 multiple-choice questions

Skills Measured

| | |
|--------------------------|-----|
| Vocabulary and structure | 33% |
| Paragraph completion | 33% |
| Reading comprehension | 33% |

FORMAT/CONTENT — SPANISH with LISTENING

Approximate
% of Test

85 multiple-choice listening and reading questions

Listening Section (20 minutes) 40%

Pictures
Rejoinders
Selections

Reading Section (40 minutes) 60%

Vocabulary and structure
Paragraph completion
Reading comprehension

Sample Reading Questions

There are three types of reading questions, grouped into separate parts. Each part accounts for approximately one-third of the total score. All questions in the test are multiple-choice questions in which you must choose the BEST response from the four choices offered.

Part A

Directions

This part consists of a number of incomplete statements, each having four suggested completions. Select the most appropriate completion and fill in the corresponding circle on the answer sheet.

1. Los cubanos están muy orgullosos de ----- larga tradición folclórica.
(A) suyos (B) sus
(C) suya (D) su
2. Se sabe que la playa de Luquillo es muy popular porque la gente de San Juan la visita ----- .
(A) en resumidas cuentas (B) en punto
(C) a medias (D) a menudo

3. Si ----- en el Brasil, hablaríamos portugués y no español.

- (A) vivamos (B) vivimos
(C) vivíamos (D) viviéramos

Part B

Directions

Directions: In the following paragraph, there are numbered blanks indicating that words or phrases have been omitted. For each numbered blank, four completions are provided. First, read through the entire passage. Then, for each numbered blank, choose the completion that is most appropriate given the context of the entire paragraph and fill in the corresponding circle on the answer sheet.

La máquina más infernal de hacer dinero se llama "Pedroso," un osito electrónico que (4) ha derramado sobre sus fabricantes beneficios superiores a los 100 millones de dólares en el (5) año. La (6) de Pedroso es que habla. Claro, no hay ningún misterio en la cinta sin fin y el grabador (7) en el interior del osito. Pero lo (8) novedoso es que (9) hablar su boca se mueve en sincronía con las palabras y sus ojos pestañean. El juguete (10) vende a precios que oscilan entre 60 y 80 dólares.

4. (A) todavía (B) nunca
(C) ya (D) tampoco
5. (A) primero (B) primer
(C) primo (D) primario
6. (A) oportunidad (B) mayoría
(C) desventaja (D) particularidad
7. (A) ocultos (B) lejanos
(C) cobrados (D) llenos
8. (A) verdaderamente (B) antiguamente
(C) ansiosamente (D) perezosamente
9. (A) del (B) en
(C) al (D) de
10. (A) se (B) le
(C) lo (D) los

Part C

Directions

Read the following texts carefully for comprehension. Each text is followed by a number of questions or incomplete statements. Select the answer or completion that is BEST according to the passage and fill in the corresponding circle on the answer sheet.

Alcanzó la carretera central y pisó el acelerador. Se cruzó con varios camiones del ejército y con una ambulancia de la Cruz Roja. Sara hablaba incoherentemente a su lado.

—Pararemos en algún lugar. Un café nos hará bien.

En Santa Fe cayeron las primeras gotas. Álvaro las vio caer en los cristales como frutas maduras y, a los pocos segundos, el espacio se convirtió en una cortina de agua. Era la lluvia violenta del trópico acompañada de un viento colérico y del fuego brutal de los relámpagos. Los limpiacristales oscilaban inútilmente en abanico con un ruido sordo.

11. ¿Dónde se desarrolla esta narración?
(A) En una casa (B) En un automóvil
(C) En un café (D) En un cuartel
12. ¿Qué desea Álvaro?
(A) Abrir la cortina (B) Comer una fruta
(C) Tomar un café (D) Encender la luz

La tranquilidad de sentirse bien atendido.



Cuando viaje por negocios, por ocio o por estudios, disfrute plenamente de la tranquilidad de viajar bien atendido con **EUROPEA DE SEGUROS** y desprecúpese de accidentes, asistencia médica, equipajes, anulaciones, demoras, etc.

Viaje tranquilo. **EUROPEA** pone a su disposición el seguro más amplio y más completo para cada tipo de viaje.



**COMPañIA EUROPEA
DE SEGUROS, S.A.**

13. ¿Cuál de los siguientes beneficios ofrece esta compañía de seguros?
(A) Reparación de autos
(B) Ayuda financiera
(C) Protección al viajar
(D) Servicios de día y noche
14. ¿Qué característica se destaca más de la compañía anunciada?
(A) Su precio
(B) Su cortesía
(C) Su rapidez
(D) Su amplitud

Sample Listening Questions

In addition to the types of reading questions on the previous page, the Spanish Test with Listening has three types of *listening* questions that test your ability to understand spoken Spanish. Please note that in the actual test, the listening section comes first.

Part A

Directions

For each question in this part, you will hear four sentences designated (A), (B), (C), and (D). They will not be printed in your test booklet. As you listen, look at the picture in your test booklet and select the choice that best reflects what you see in the picture or what someone in the picture might say. Then fill in the corresponding circle on your answer sheet. You will hear the choices only once.

You see:

1.



© Andersen Ross/Blend Images/Corbis # 42-22563231

You hear:

[Número 1

- (Woman) (A) Siempre quise ser florista.
(B) Sólo hay una persona haciendo cola.
(C) Las cebollas están baratas hoy.
(D) Creo que está por aquí.]

(7 seconds)

Part B

Directions

In this part of the test you will hear several short conversations or parts of conversations, followed by four choices designated (A), (B), (C), and (D). After you hear the four choices, choose the one that most logically continues or completes the conversation and mark your answer on your answer sheet. Neither the conversations nor the choices will be printed in your test booklet.

You hear:

[Número 2

- (Woman) Ana es una ciclista excelente.
(A) Yo tengo una camiseta nueva.
(B) La mía es mucho mejor.
(Man) (C) Y además, es muy simpática.
(D) La motocicleta también es buena.]

(7 seconds)

You hear:

[Número 3

- (Woman) ¿Algo más, señor? Tenemos unas ofertas especiales hoy.
(Man) No, gracias. ¿Puedo pagar con tarjeta de crédito?
(Woman) (A) Claro que sí.
(B) Salga usted ahora mismo.
(C) No aceptamos monedas.
(D) No, no tengo cambio.]

(7 seconds)

Part C

Directions

Directions: You will now hear a series of selections. For each selection, you will see printed in your test booklet one or more questions with four possible answers. They will not be spoken. Select the best answer to each question from among the four choices printed and fill in the corresponding circle on your answer sheet. You will have twelve seconds to answer each question.

You hear:

[Selección número 1

- (Narrator) Escuchen esta conversación en la taquilla del Teatro Colón.
(Man) Buenas tardes, señorita. ¿Todavía hay entradas para el programa del sábado? Necesito dos.
(Woman) No, ya no quedan.]

(Man) Entonces, ¿para el domingo?
 (Woman) Ah, sí, para el domingo sí hay.
 (Man) ¿Es el mismo programa?
 (Woman) No, es diferente; es un concierto de música clásica.
 (Man) Entonces, deme dos entradas, por favor.
 (Narrator) Ahora contesten las preguntas 4 y 5.]
 (24 seconds)

You read:

Selección número 1

4. ¿Para cuándo quedan entradas?

- (A) Para la tarde
- (B) Para el sábado
- (C) Para el domingo
- (D) Para la próxima semana

5. ¿Qué programa presentan el domingo?

- (A) Una comedia
- (B) Una ópera
- (C) Un concierto
- (D) Un ballet

You hear:

[Selección número 2

(Narrator) Y ahora, el pronóstico del tiempo.

(Man) Para mañana se anuncian fuertes aguaceros en la zona de la costa. Posibilidad de inundaciones en algunas áreas. Temperatura máxima de 25 grados centígrados. Leve mejora a partir del sábado.

(Narrator) Ahora contesten la pregunta 6.]

(12 seconds)

You read:

Selección número 2

6. ¿Qué se anuncia para el día siguiente?

- (A) Sol
- (B) Lluvia
- (C) Viento
- (D) Frío

ANSWERS

The estimated difficulty level, on a scale of 1 to 5, with 1 the easiest and 5 the most difficult, is in parentheses.

Reading Questions

- | | | | |
|----------|----------|-----------|-----------|
| 1. D (1) | 5. B (2) | 9. C (3) | 13. C (3) |
| 2. D (3) | 6. D (3) | 10. A (3) | 14. D (5) |
| 3. D (5) | 7. A (3) | 11. B (2) | |
| 4. C (3) | 8. A (3) | 12. C (2) | |

Listening Questions

- | | | |
|----------|----------|----------|
| 1. D (2) | 3. A (3) | 5. C (2) |
| 2. C (3) | 4. C (2) | 6. B (4) |

Answer explanations for these practice questions are available online. Visit sat.collegeboard.org/practice/spanish to view and download the complete document.

Acceptable Graphing Calculators

The following graphing calculators are permitted on the SAT:

Casio

FX-6000 series
FX-6200 series
FX-6300 series
FX-6500 series
FX-7000 series
FX-7300 series
FX-7400 series
FX-7500 series
FX-7700 series
FX-7800 series
FX-8000 series
FX-8500 series
FX-8700 series
FX-8800 series

FX-9700 series
FX-9750 series
FX-9860 series
CFX-9800 series
CFX-9850 series
CFX-9950 series
CFX-9970 series
FX 1.0 series
Algebra FX 2.0 series
FX-CG-10 (PRIZM)
FX-CG-20

Hewlett-Packard

HP-9G
HP-28 series
HP-38G
HP-39 series
HP-40 series
HP-48 series
HP-49 series
HP-50 series
HP Prime

Radio Shack

EC-4033
EC-4034
EC-4037

Sharp

EL-5200
EL-9200 series
EL-9300 series
EL-9600 series*
EL-9900 series

*The use of the stylus is not permitted.

Other

Datexx DS-883
Micronta
Smart²

Texas Instruments

TI-73
TI-80
TI-81
TI-82
TI-83/TI-83 Plus
TI-83 Plus Silver
TI-84 Plus
TI-84 Plus Silver
TI-84 Plus C Silver
TI-85
TI-86
TI-89
TI-89 Titanium
TI-Nspire
TI-Nspire CX
TI-Nspire CM-C
TI-Nspire CAS
TI-Nspire CX CAS
TI-Nspire CAS CX-C

Get **FREE AND AFFORDABLE**
SAT[®] practice tools
from the test maker



Available at sat.org/practice

- Free SAT practice tools including:
 - Official practice test
 - Video tutorials and other practice materials from Khan Academy
- The Official SAT Study Guide™ (also available with DVD)
- The Official SAT Online Course™ (valid until January 2016)

SAT[®]

 **CollegeBoard**

© 2014 The College Board.
13b-8637c

Visit College Board on the Web for up-to-date information

| | |
|-----------------------------------|---|
| U.S. Test Dates | sat.org/us-dates |
| U.S. Fees | sat.org/us-fees |
| Fee Waivers | sat.org/fee-waivers |
| International Test Dates | sat.org/international |
| International Fees | sat.org/intl-fees |
| SAT Subject Tests Calendar | sat.org/subject-dates |
| Registering by Mail | sat.org/register |
| Test-Day Requirements | sat.org/test-day |
| Score Reports | sat.org/scores |
| More Online Practice | sat.org/practice |

